

SOJAG

produits saisonniers • seasonal products



Sojag code: 440-9163032

CUP/UPC code: 772830163032

QUESTIONS? 1 866-901-1649

Assembly Manual / Guide d'assemblage / Manual de ensamblaje / 조립설명서 / Montageanleitung

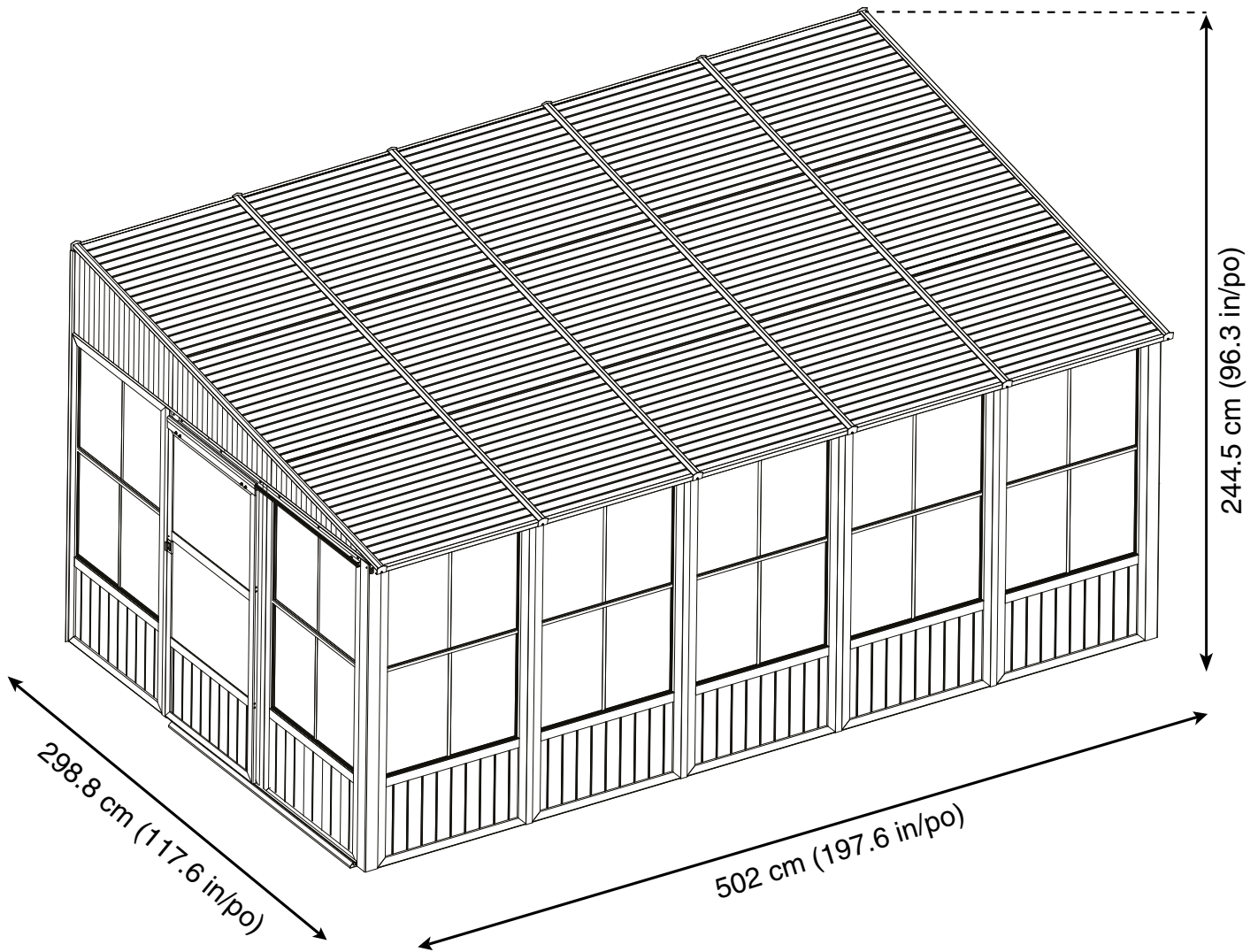

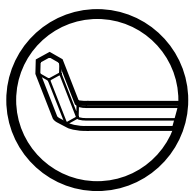

Use the hex keys in the box. / Utilisez les clés hexagonales fournies dans la boîte. / Utilice las llaves hexagonales en la caja. / 상자에 육각 키를 사용 하십시오. / Verwenden Sie die Sechskantschlüssel in der Box.

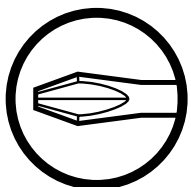

Please use a Phillips screwdriver. / Utilisez un tournevis de type Phillips / Por favor, use un destornillador Phillips. / 십자 드라이버를 사용 하십시오. / Bitte verwenden Sie einen Kreuzschraubenzieher.

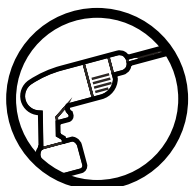

You may need to use a drill for this step. / Vous pouvez avoir besoin d'utiliser une perceuse pour cette étape. / Puede que tenga que utilizar un taladro para este paso. / 이 단계에선 드릴을 사용해야 할 수도 있습니다. / Für diesen Schritt können Sie einen Bohrer verwenden.



Wearing protective gloves is recommended. / Le port de gants de protection est recommandé / El uso de guantes de protección se recomienda. / 보호 장갑을 착용 하는 것이 좋습니다. / Das Tragen von Schutzhandschuhen wird empfohlen.



Two or more people are required at this stage. / Deux personnes ou plus sont nécessaires à cette étape. / Dos o más personas se requieren en esta etapa. / 이 단계에서는 두 명 이상이 필요합니다. / Für diesen Bauschritt sind 2 oder mehr Personen erforderlich.

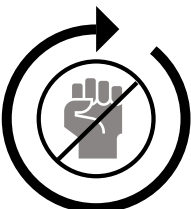

Do not tighten screws all the way for now. / Ne pas visser fermement pour l'instant. / No atornille con firmeza por ahora. / 아직 나사를 단단히 조이지 마십시오. / Bitte die Schrauben zum jetzigen Zeitpunkt noch nicht fest anziehen.

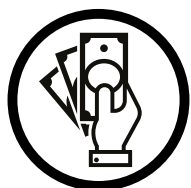

Sold separately. / Vendus séparément. / vendido en las opciones. / 옵션 판매 / Optional erhältlich

B6 X 8 (+2)

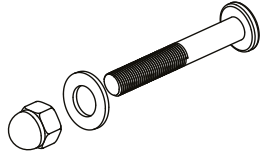

Ha X 12 (+2)

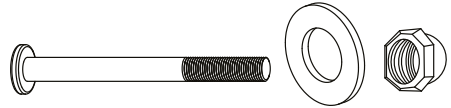

Hb X 12 (+2)

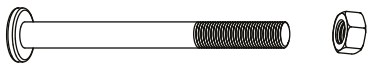

Hc X 26 (+4)

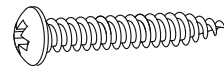

Hd X 60 (+6)

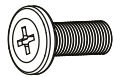

He X 20 (+4)

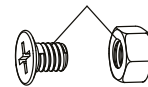

Hf X 2 (+1)

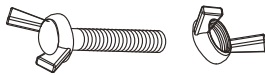

Hg X 28 (+4)

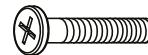

Hh X 1

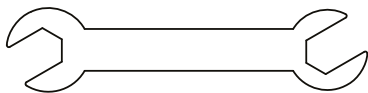

Hi X 8 (+2)

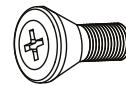



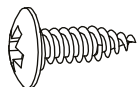

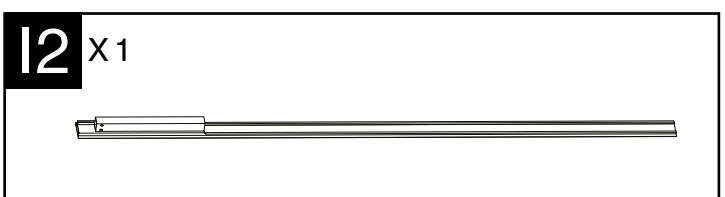
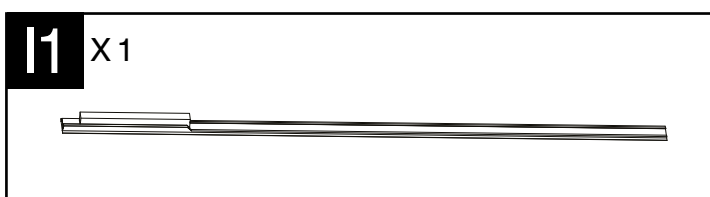
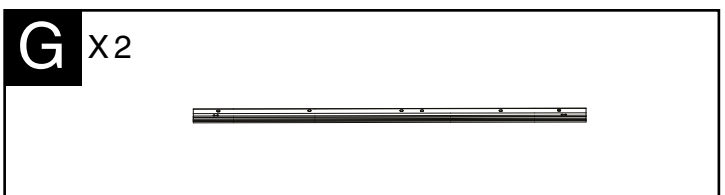
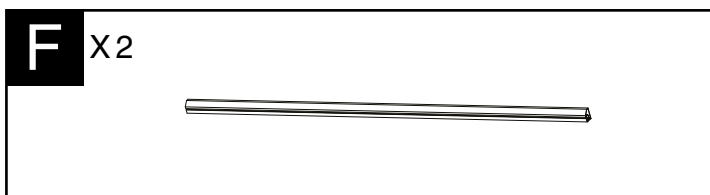
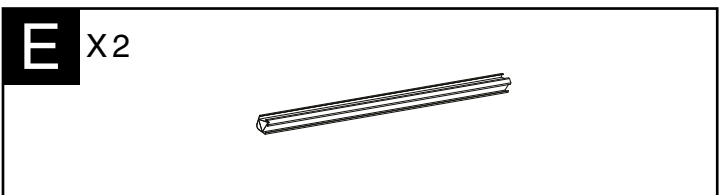
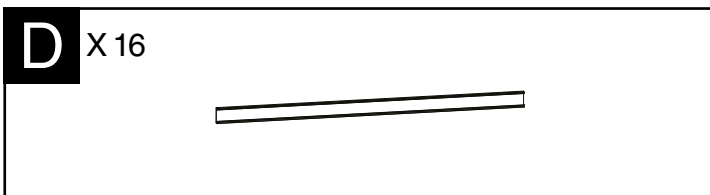
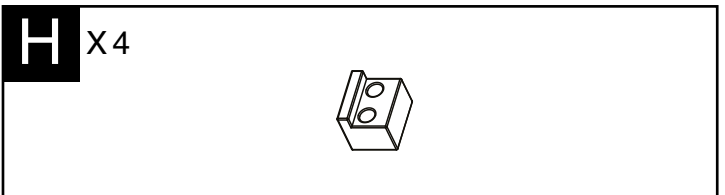
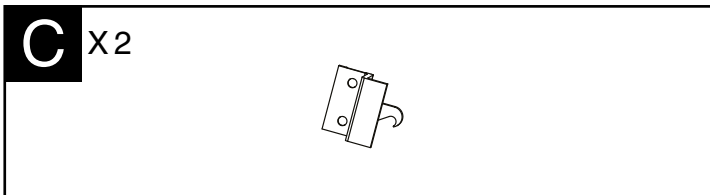
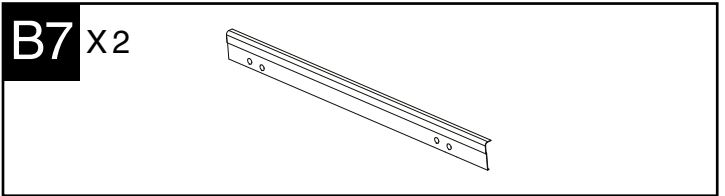
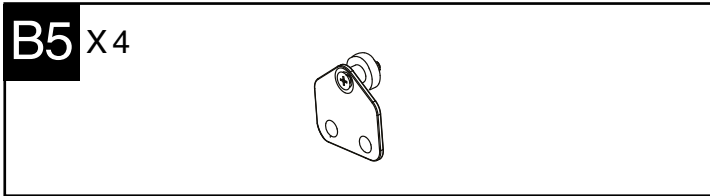
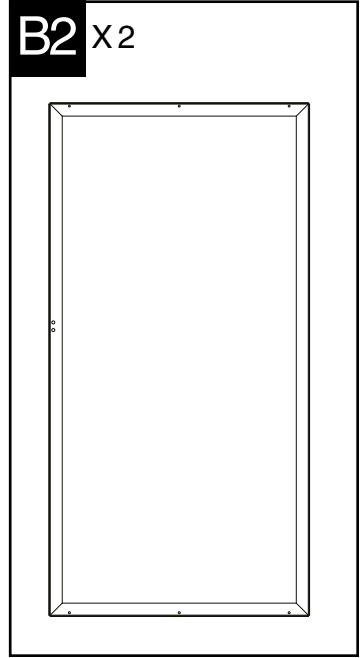
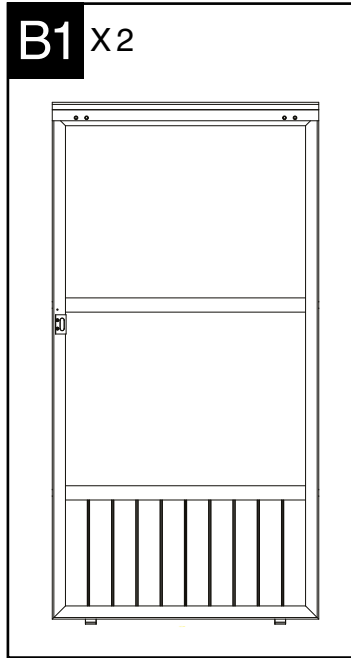
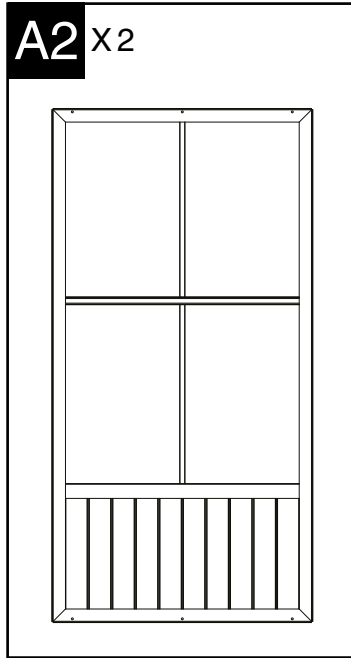
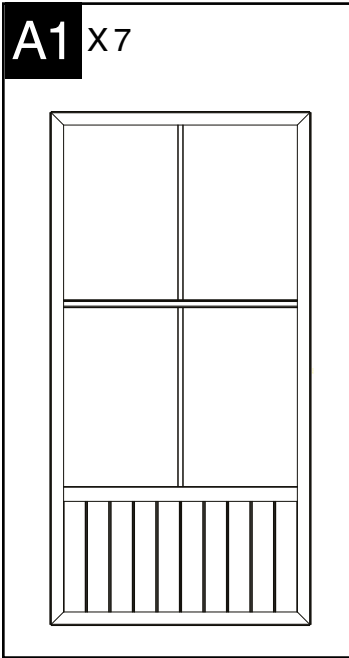

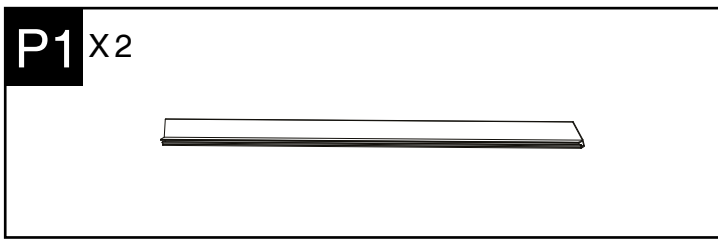
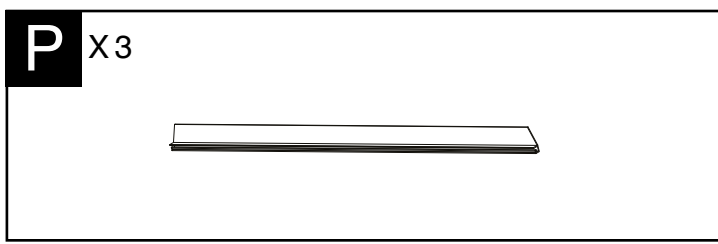
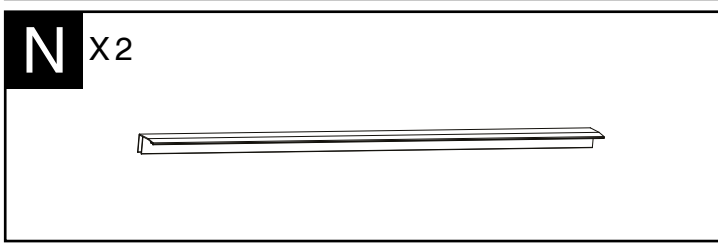
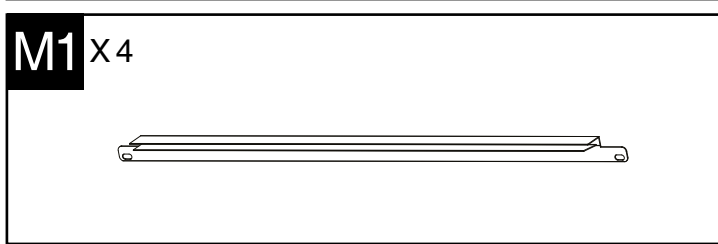
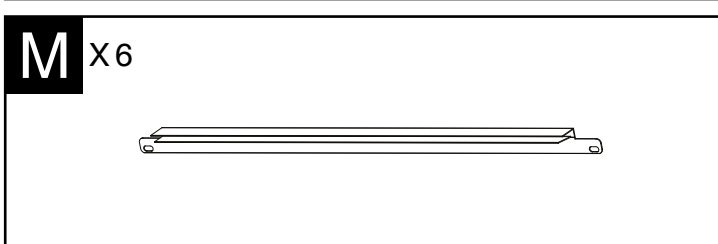
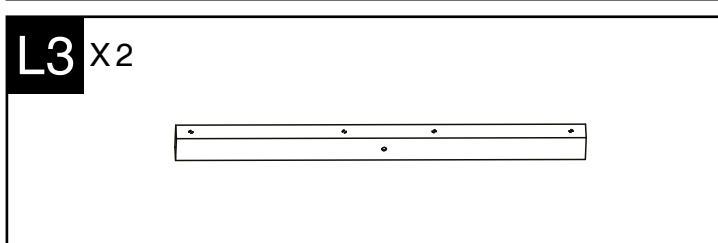
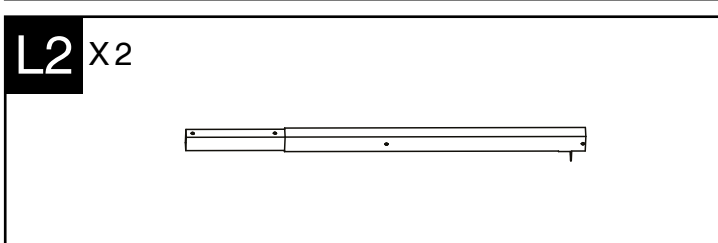
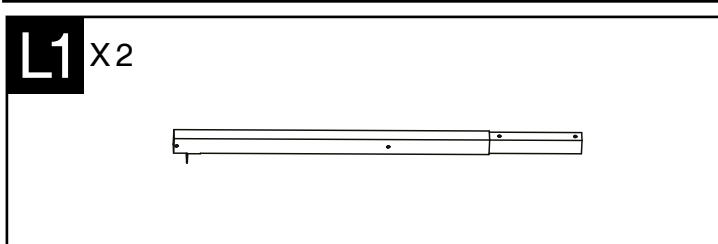
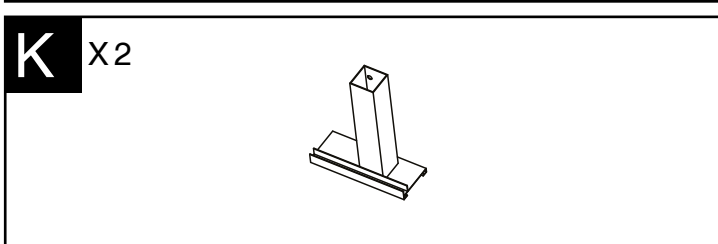
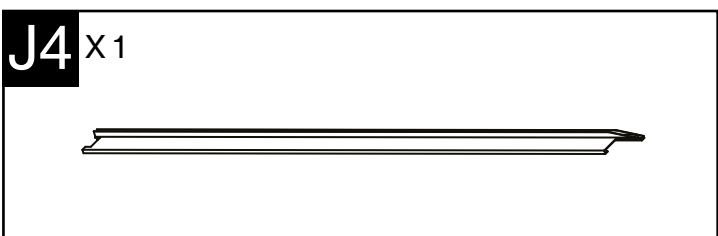
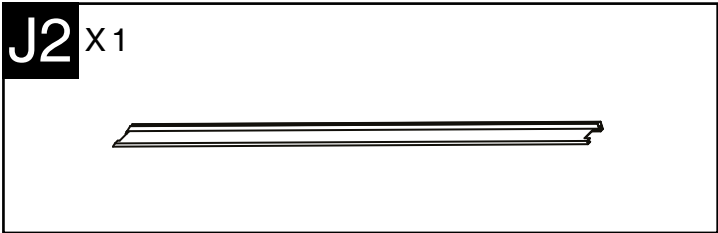
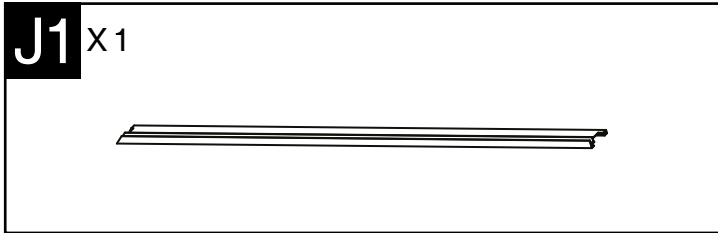



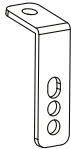
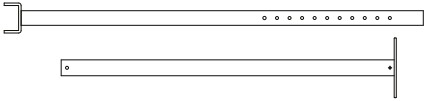

Hk X 8 (+1)

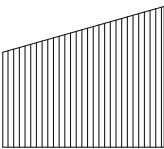
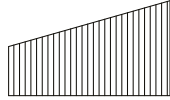

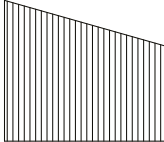
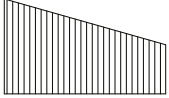

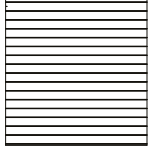

O X1 	O1 X1 
O2 X4 	Q X4 
T X4 	U X16 
R X2  	S X12 
V1 X1 	V2 X1 
V3 X1 	V4 X1 
V5 X1 	V6 X1 
W X6 	W1 X9 

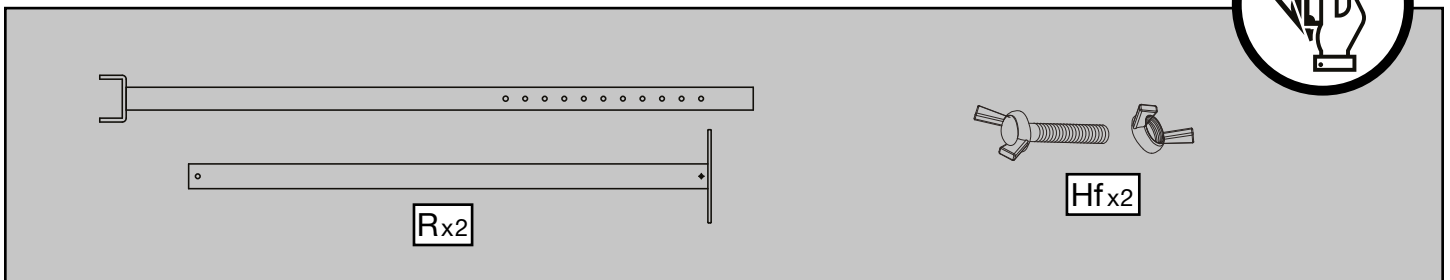
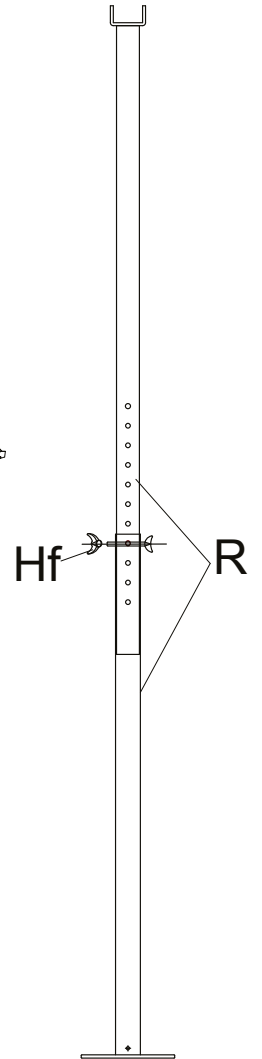
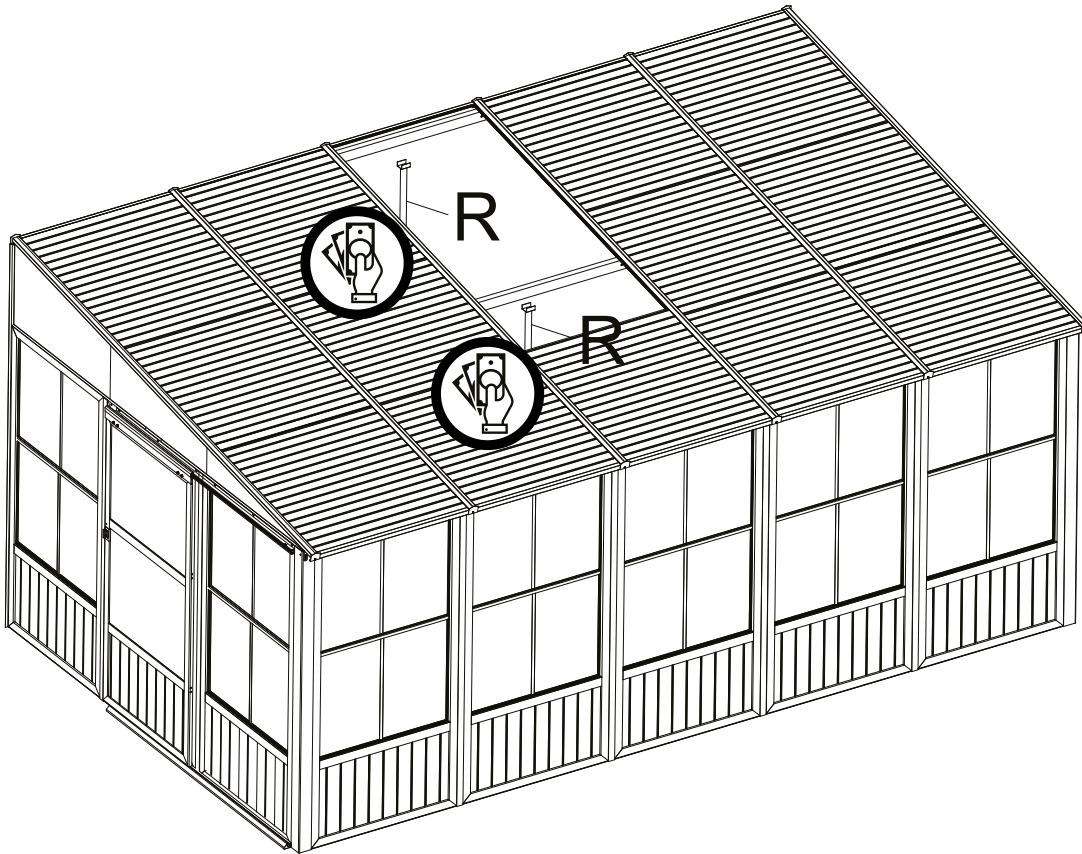

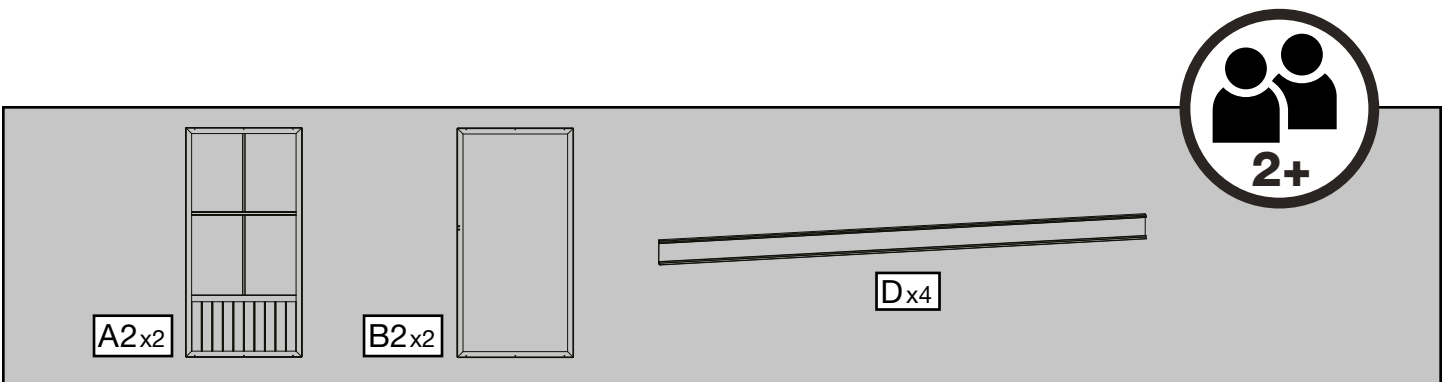
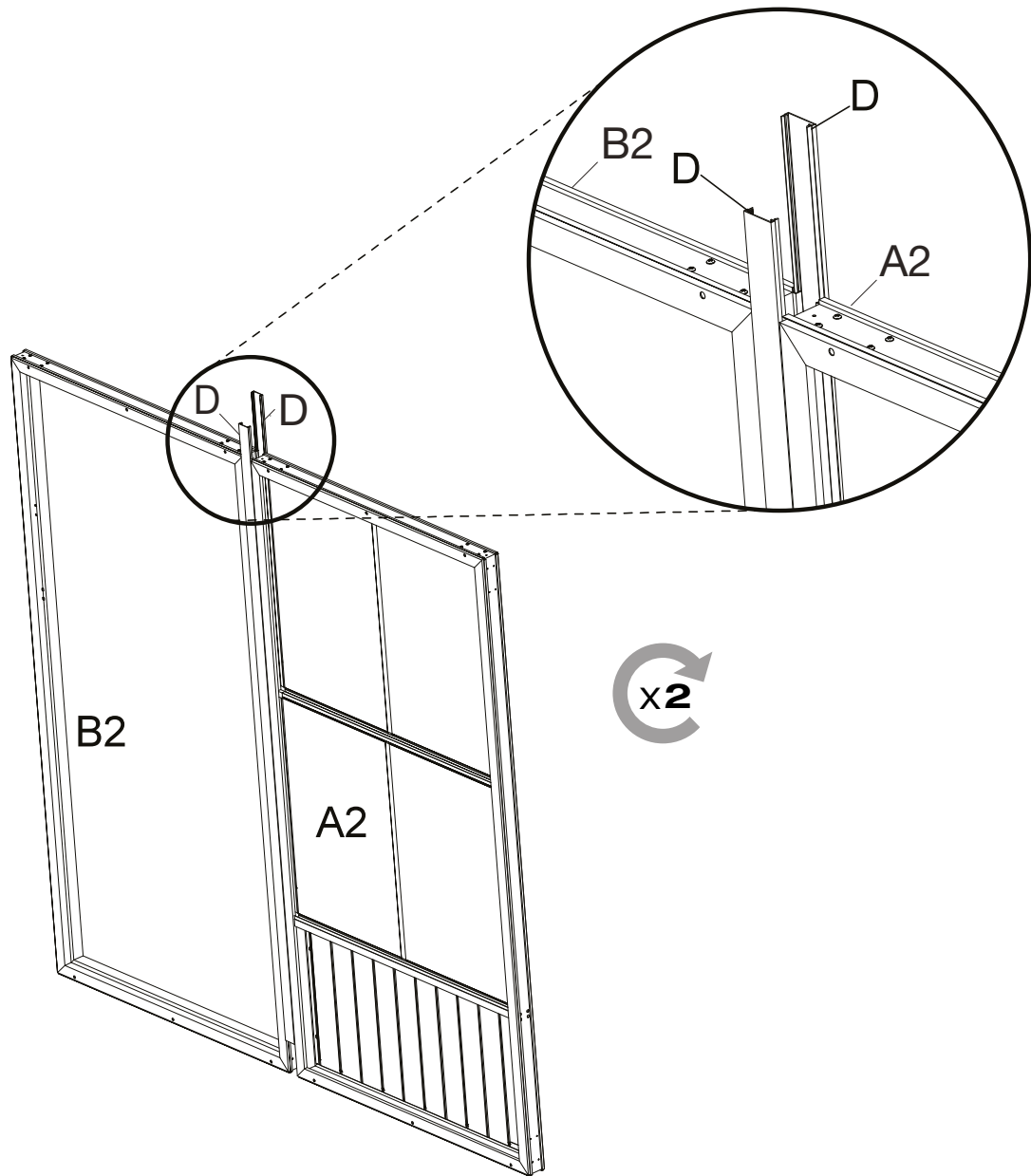

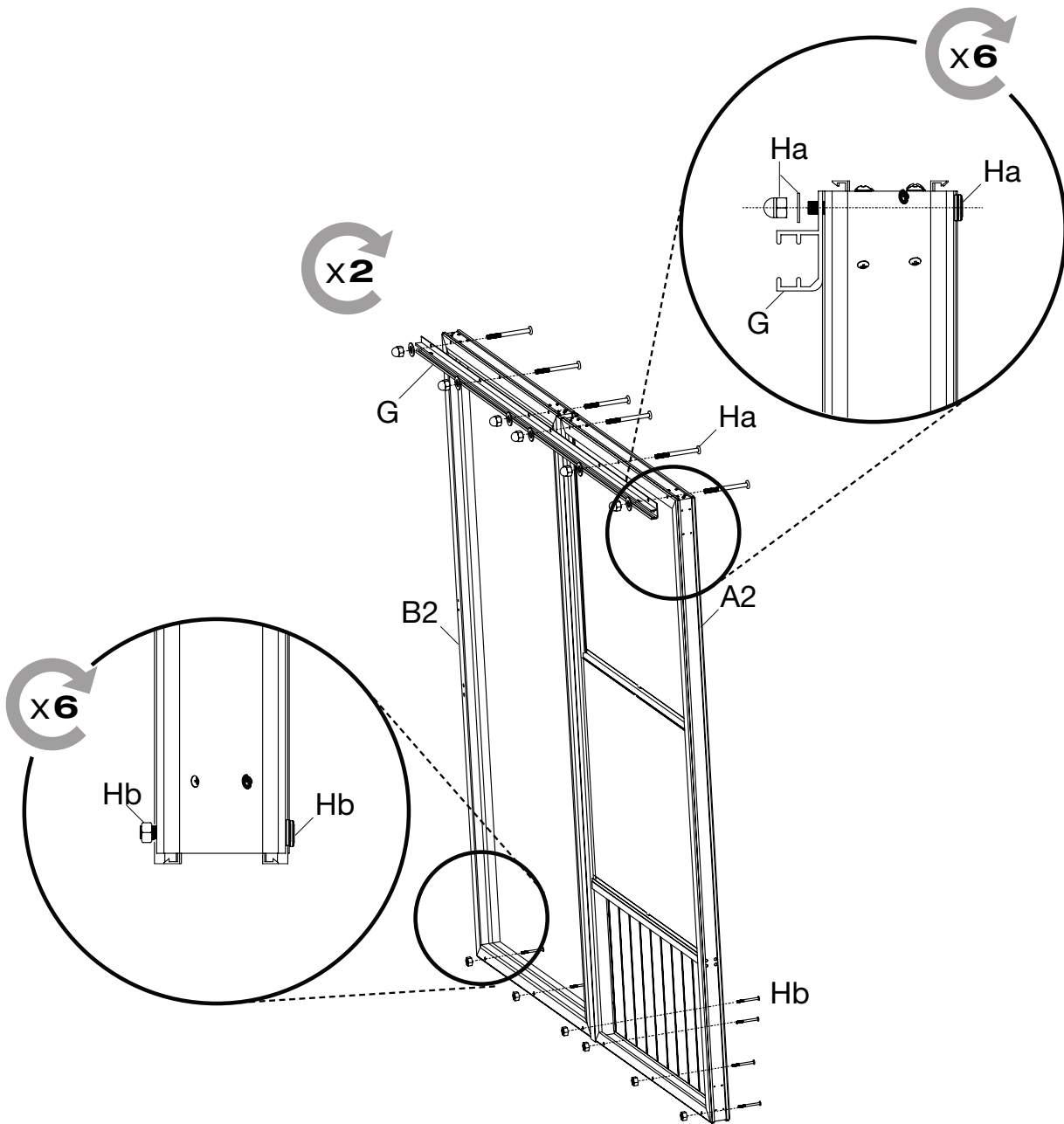

Parts List:

- Gx2**: Horizontal rail
- Hbx12**: Bottom rail connector
- Hax12**: Top rail connector

Safety Icons:

- 2+**: Requires 2 or more people.
- No Force**: Prohibits the use of force during assembly.

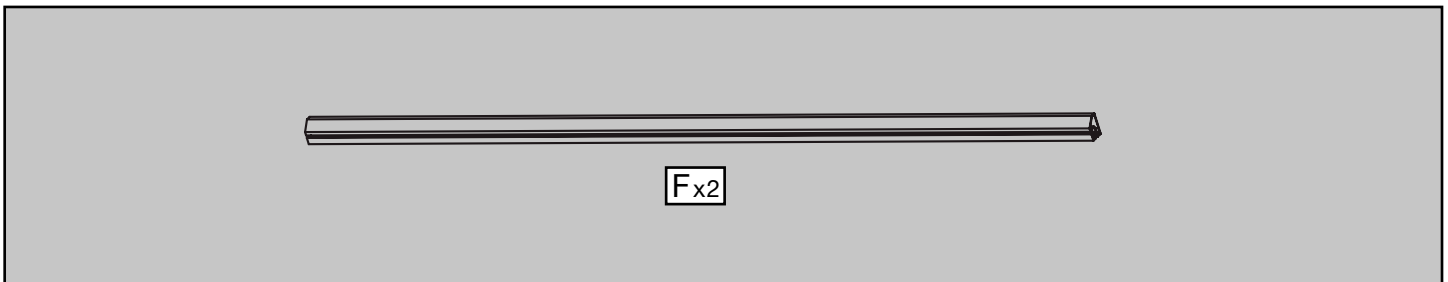
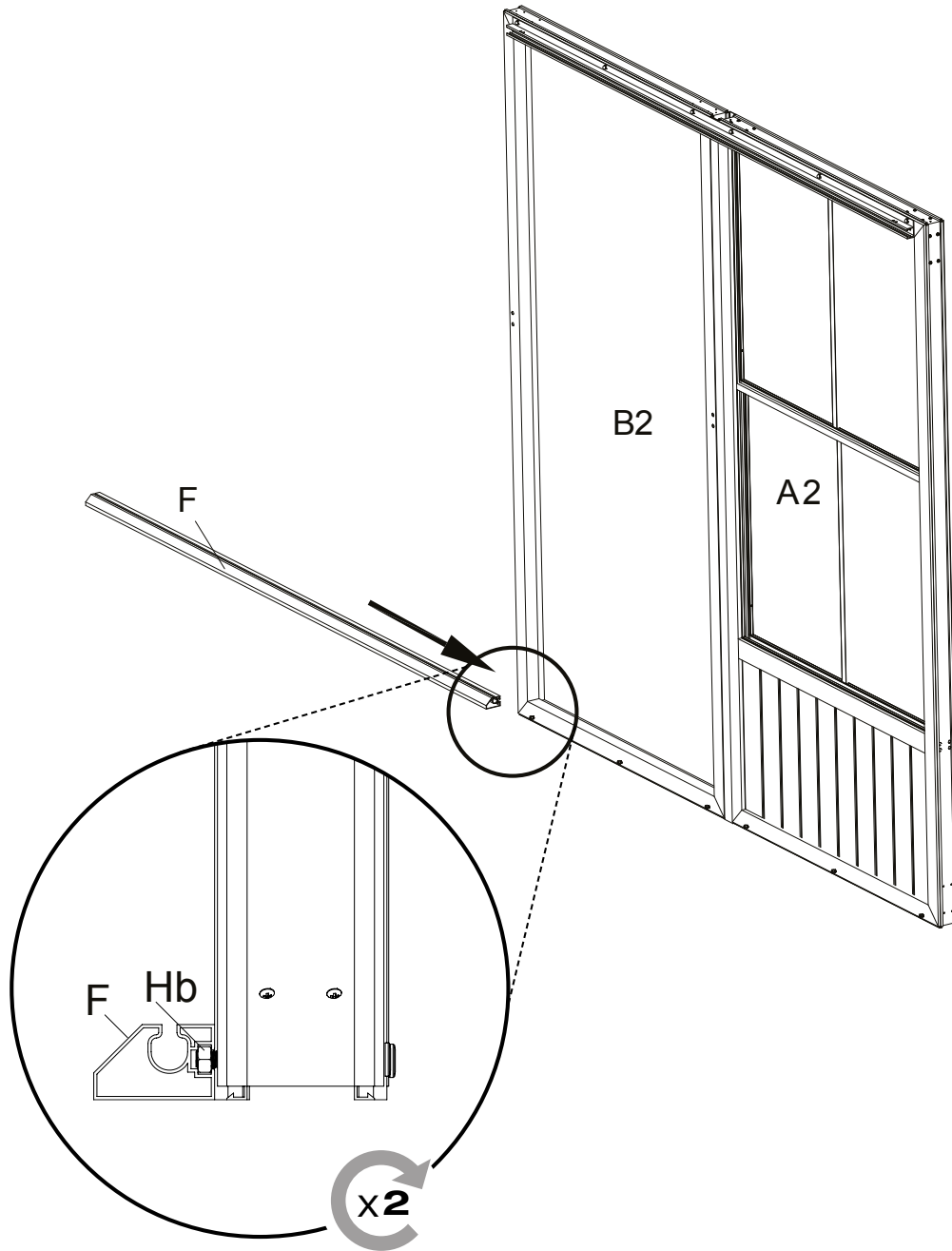

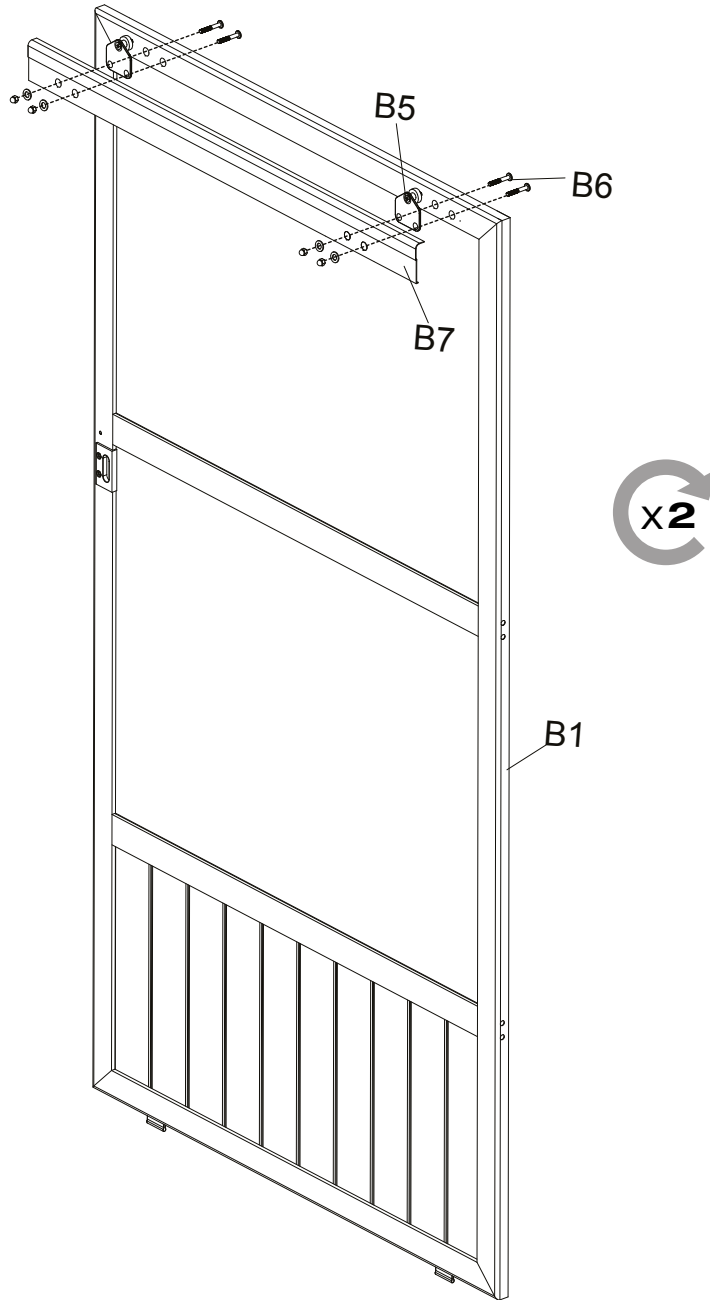

B1x2



B5x4

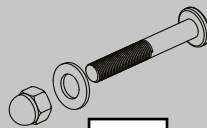

B6x8

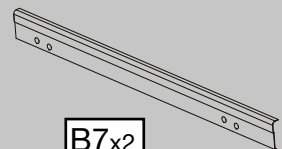

B7x2

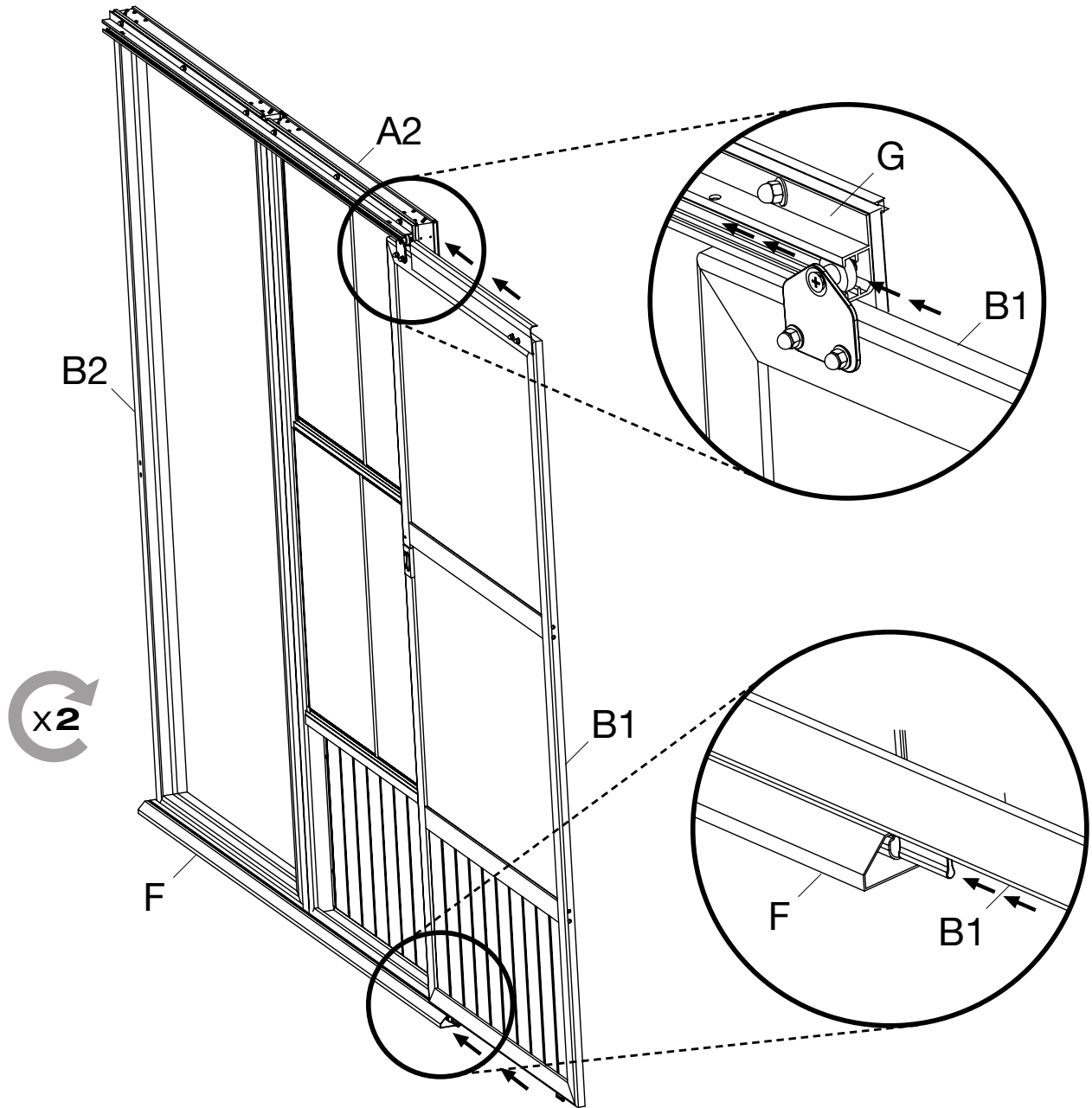

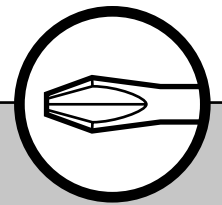
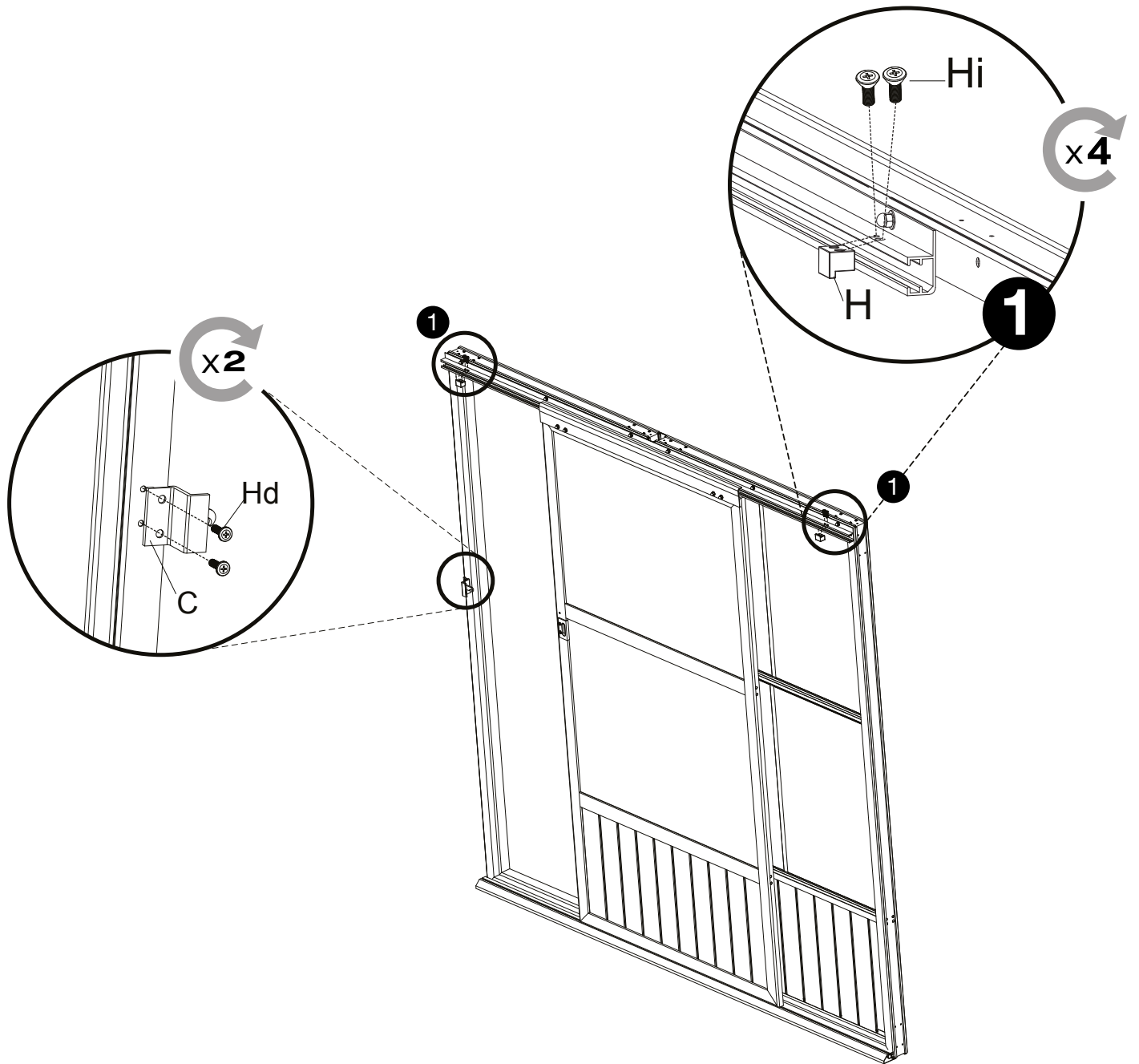

Hx4

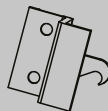

Cx2

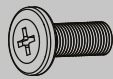

Hdx4

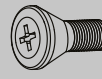

Hix8

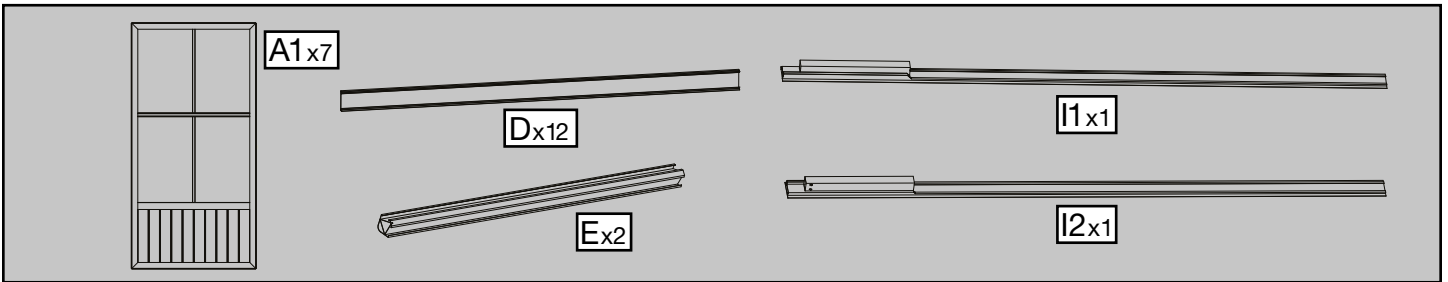
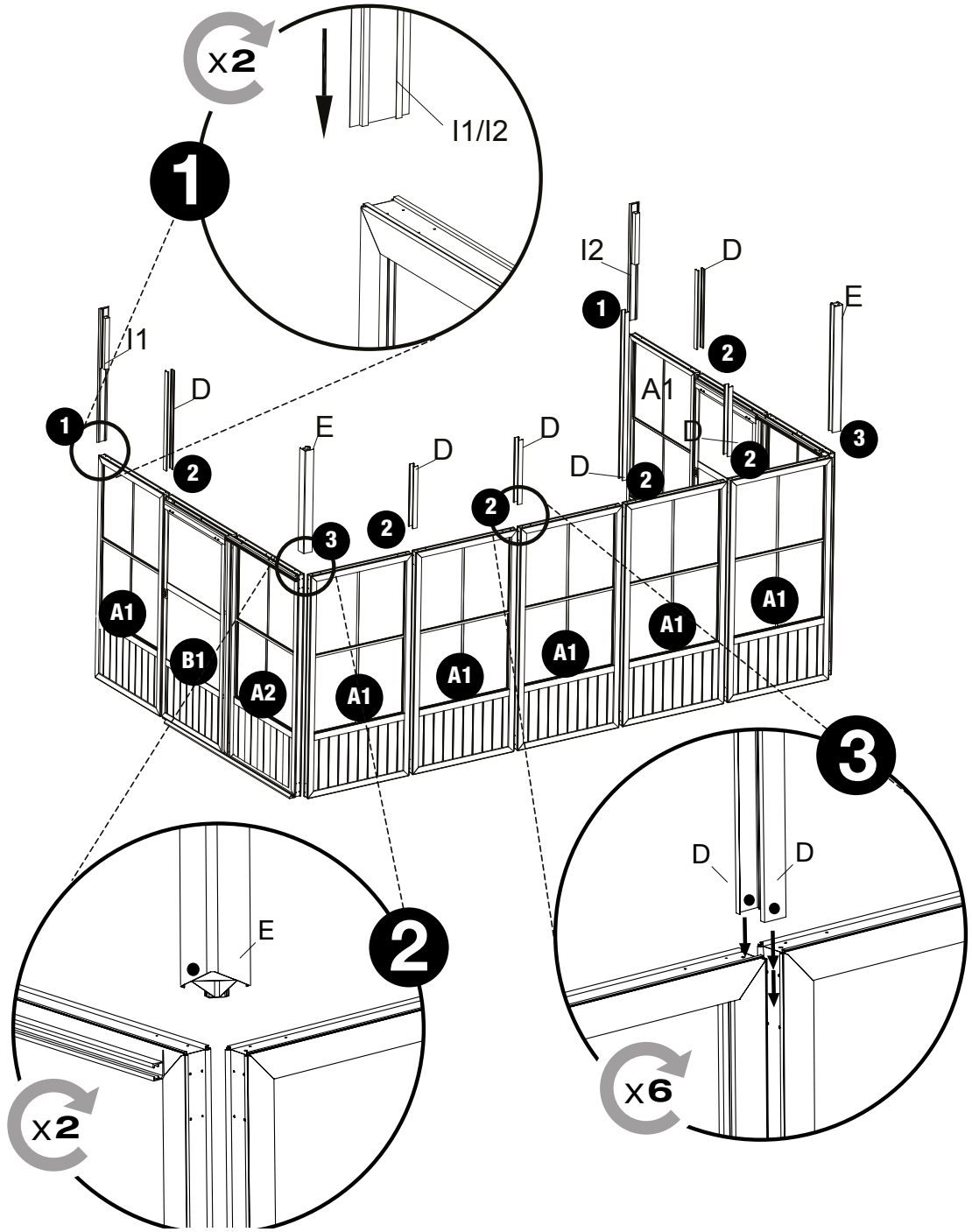

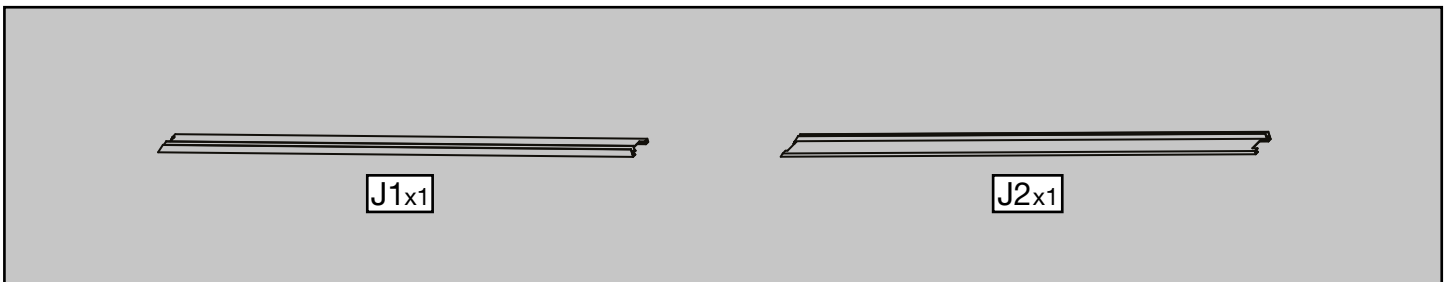
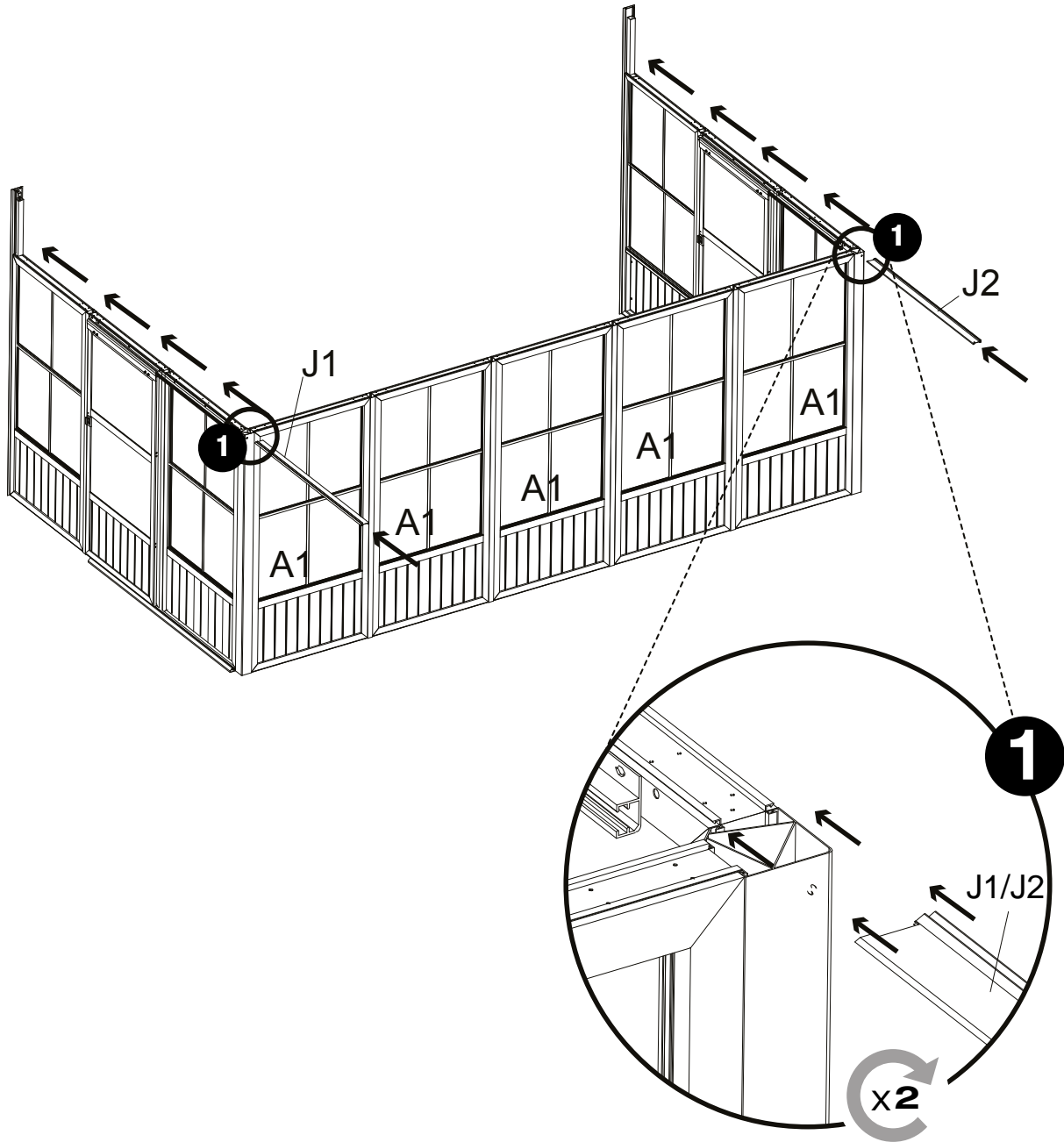

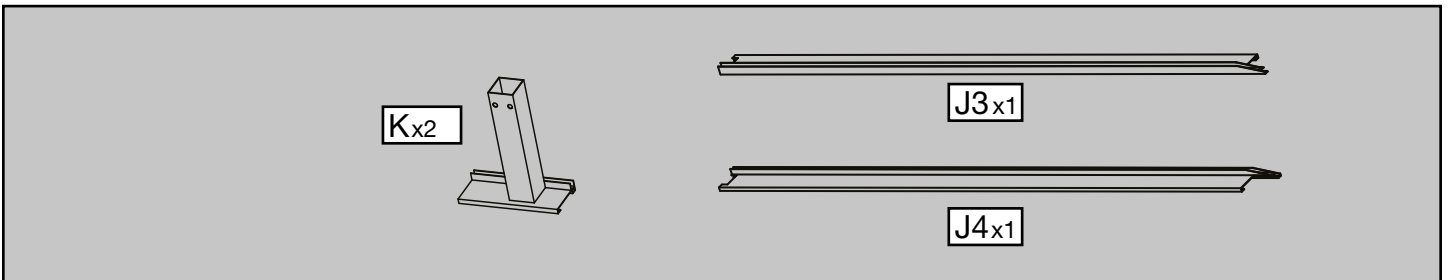
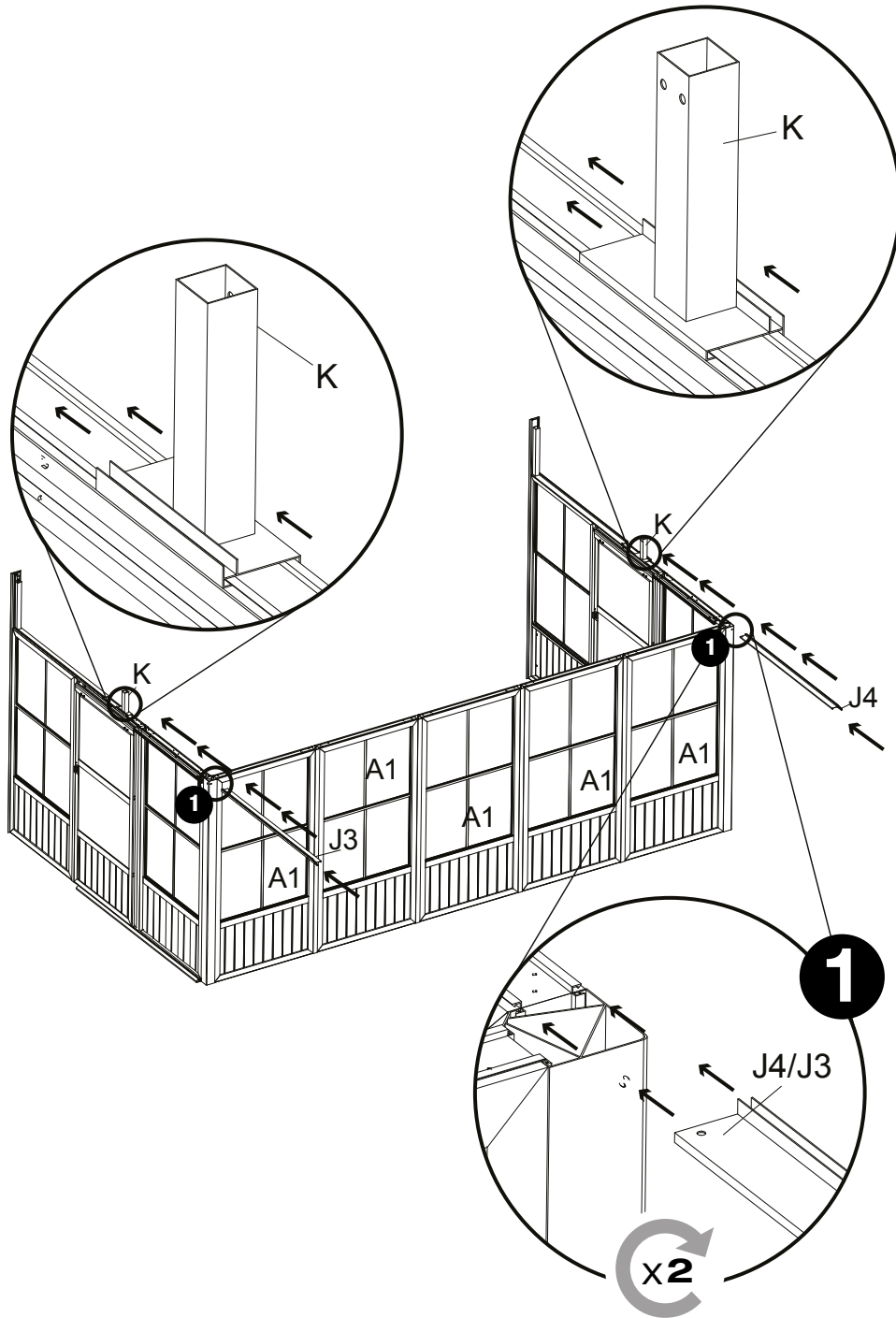

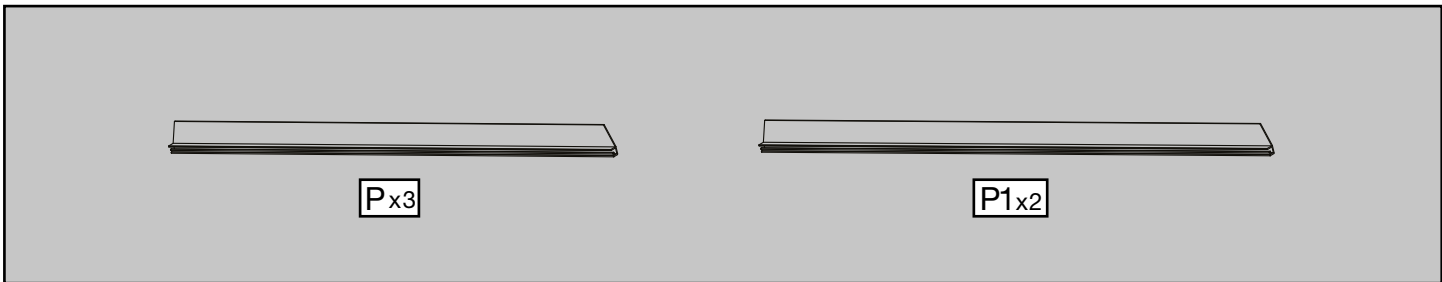
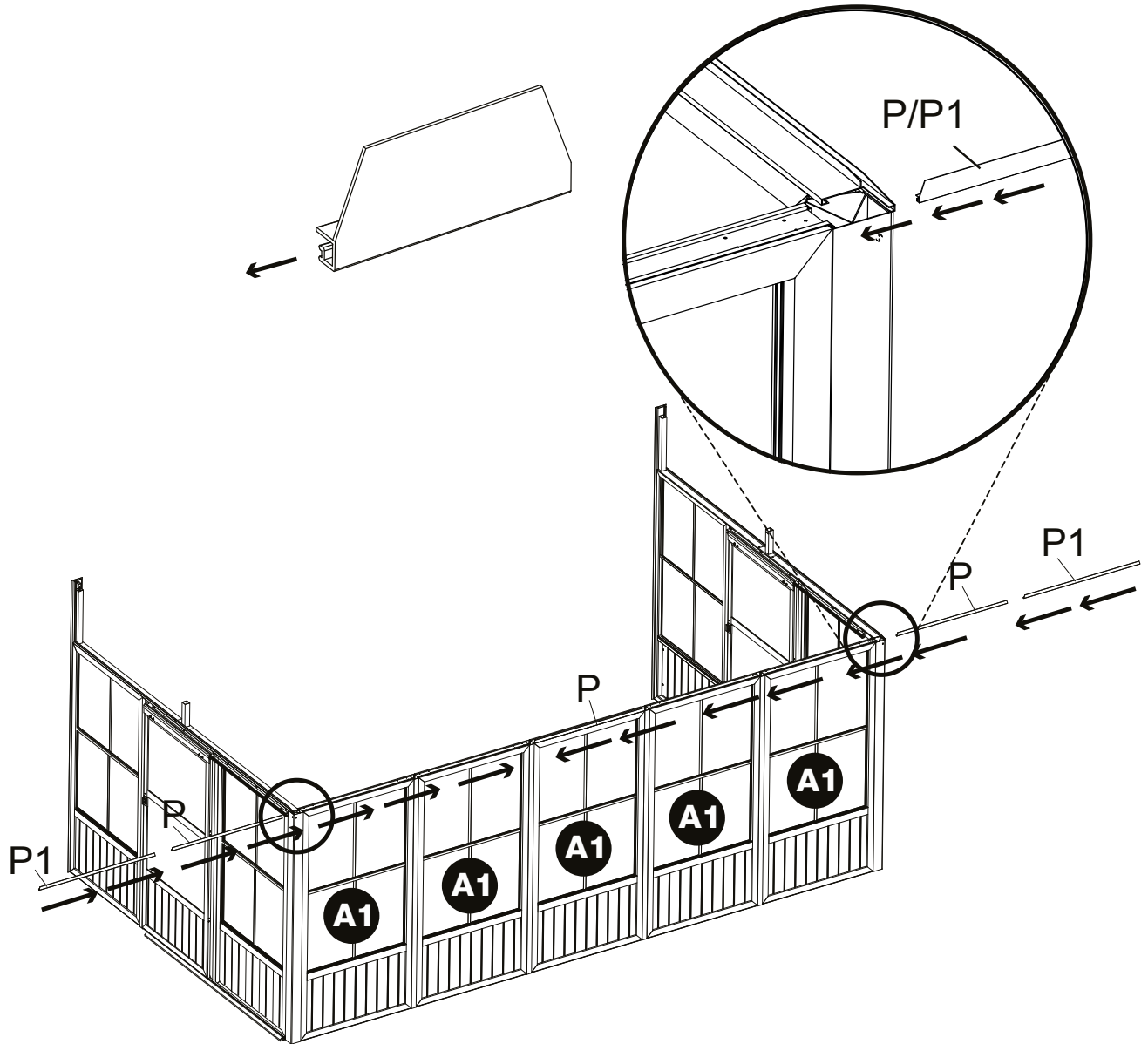

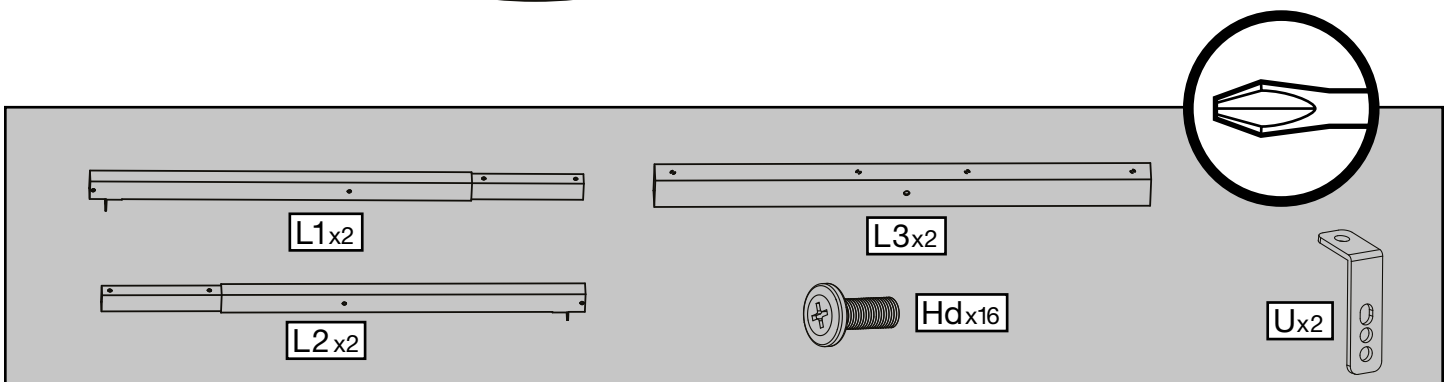
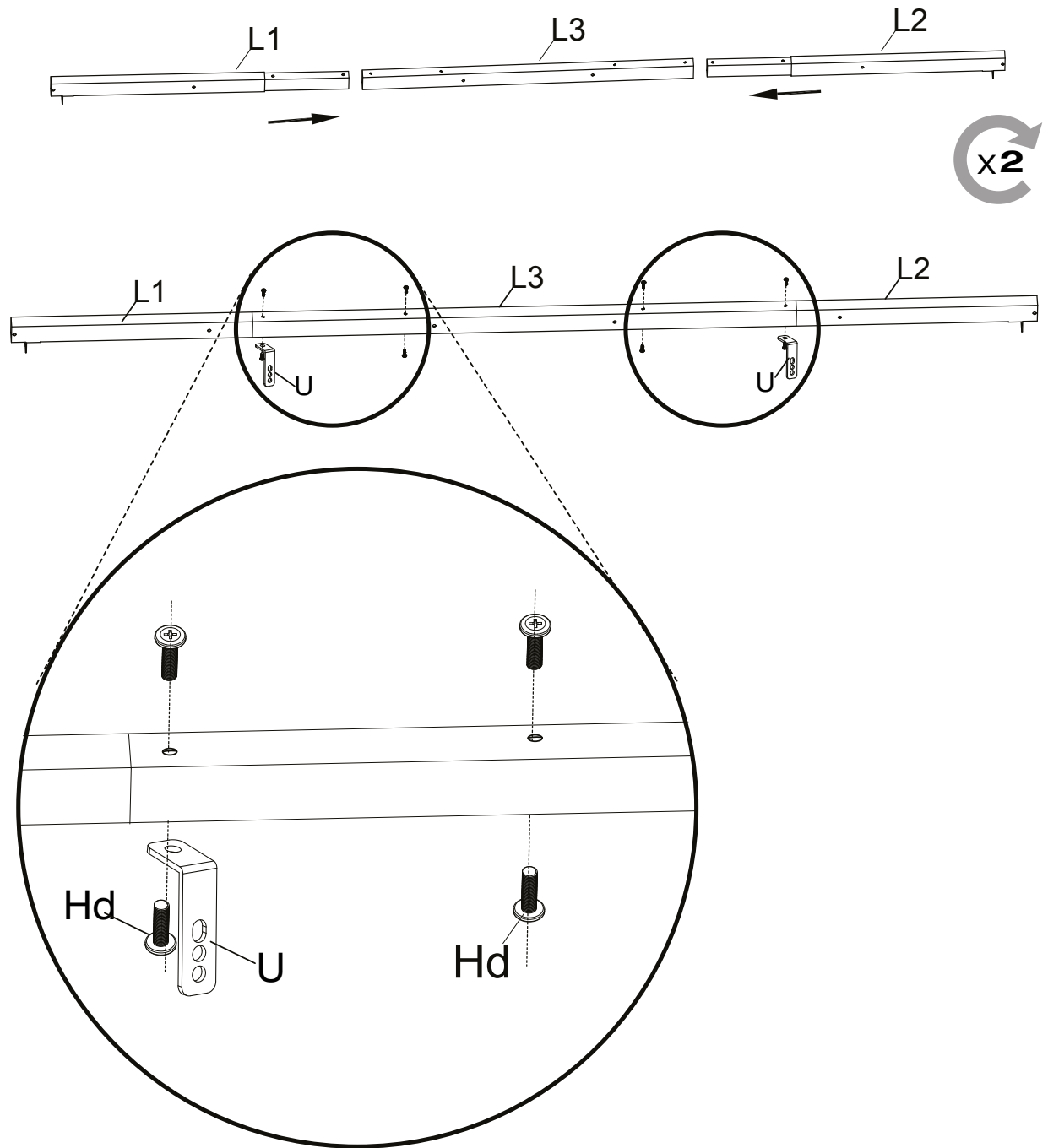

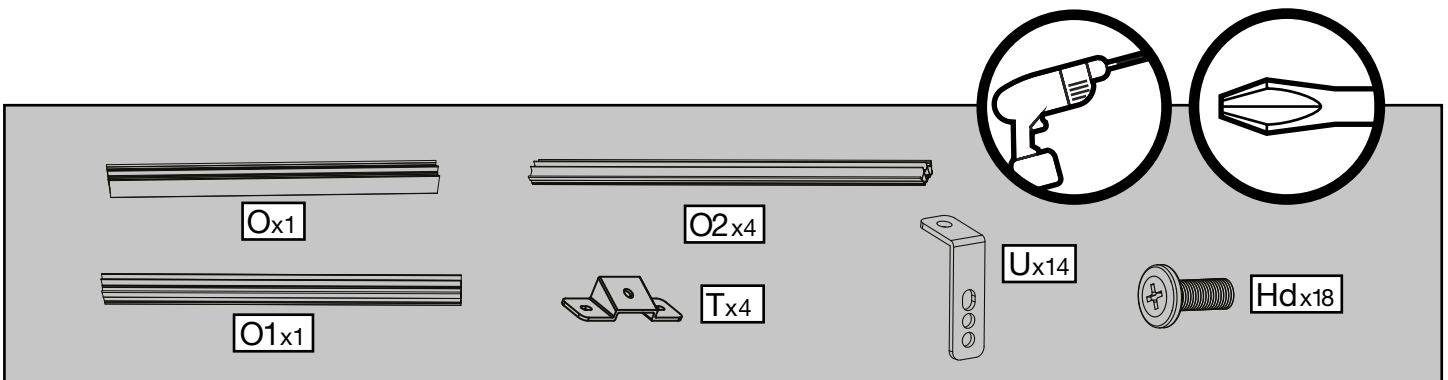
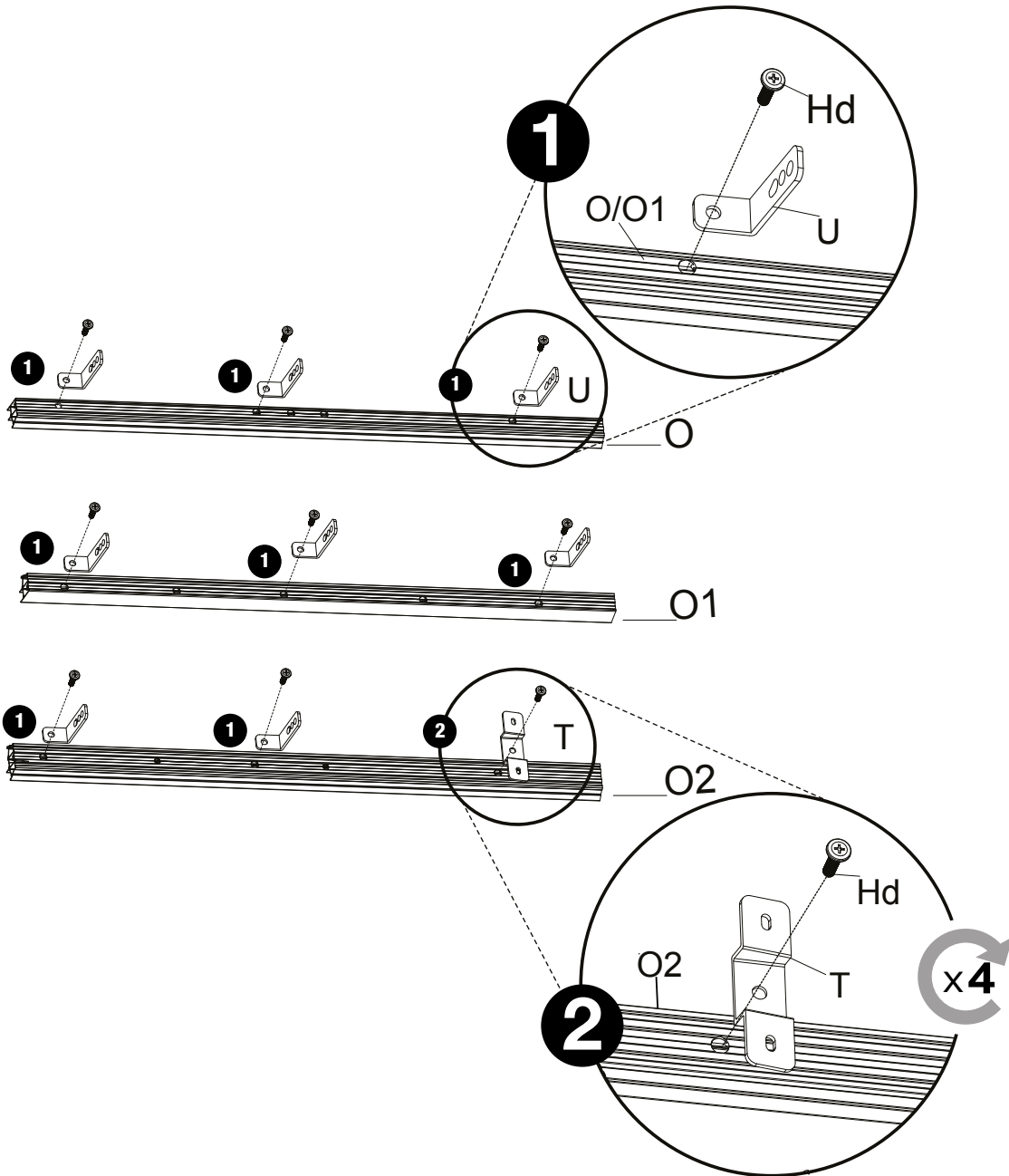

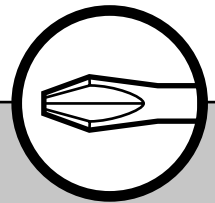
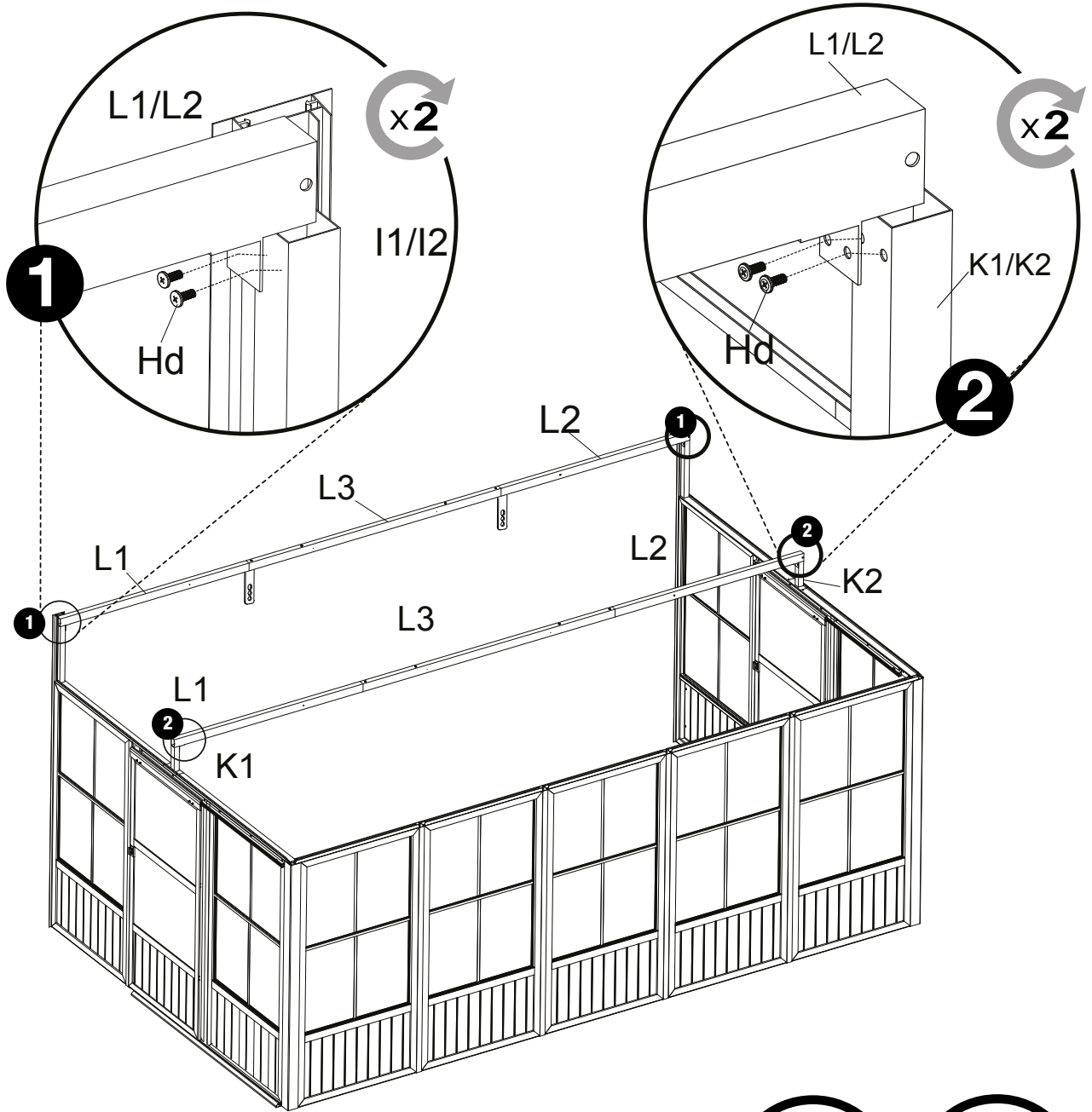

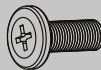
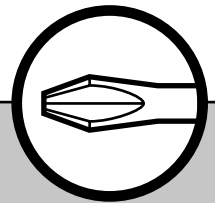
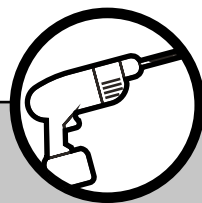
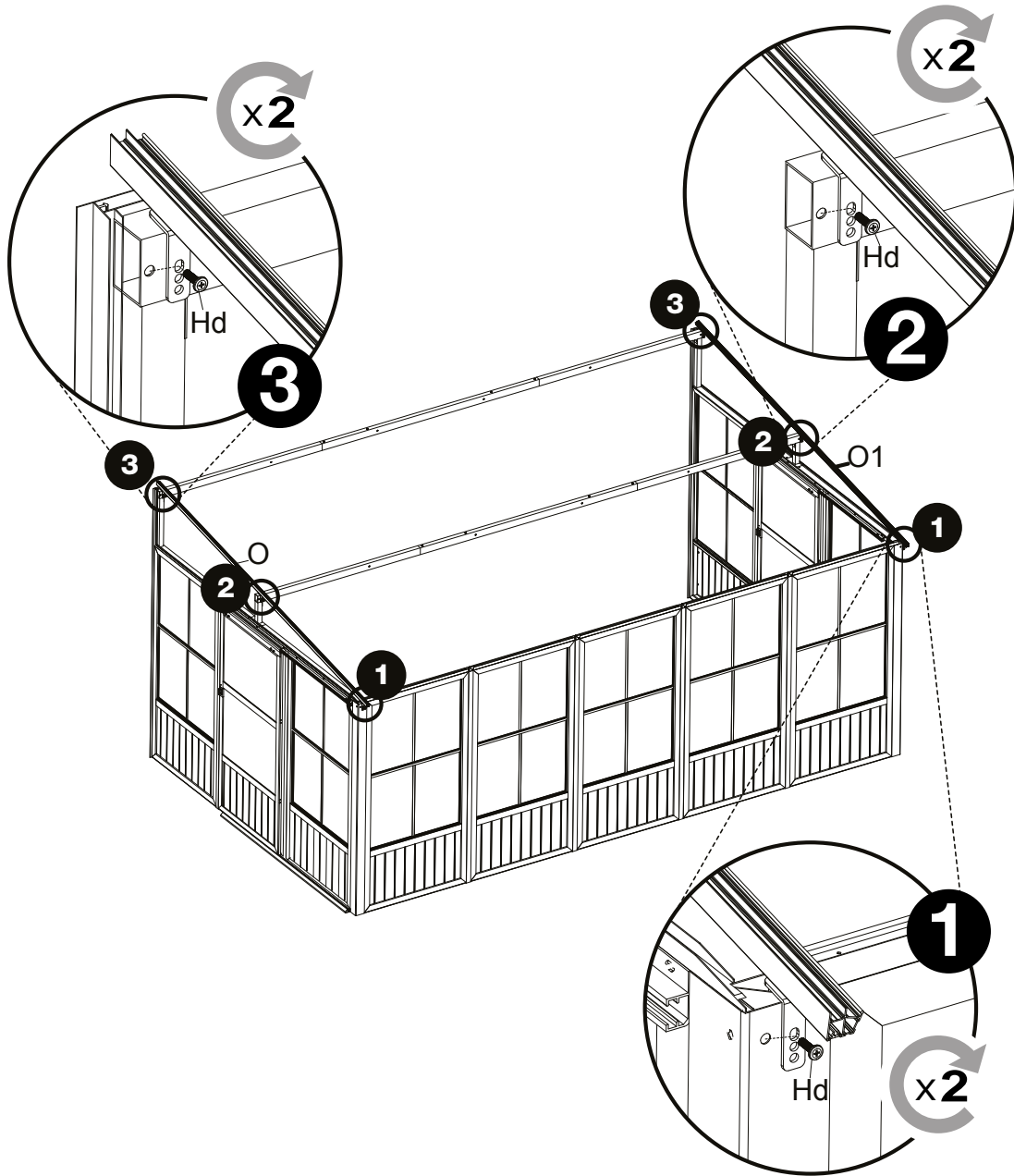

Hd x6

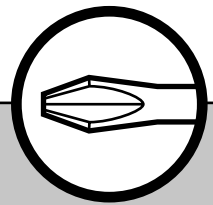
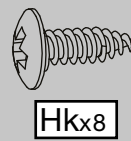
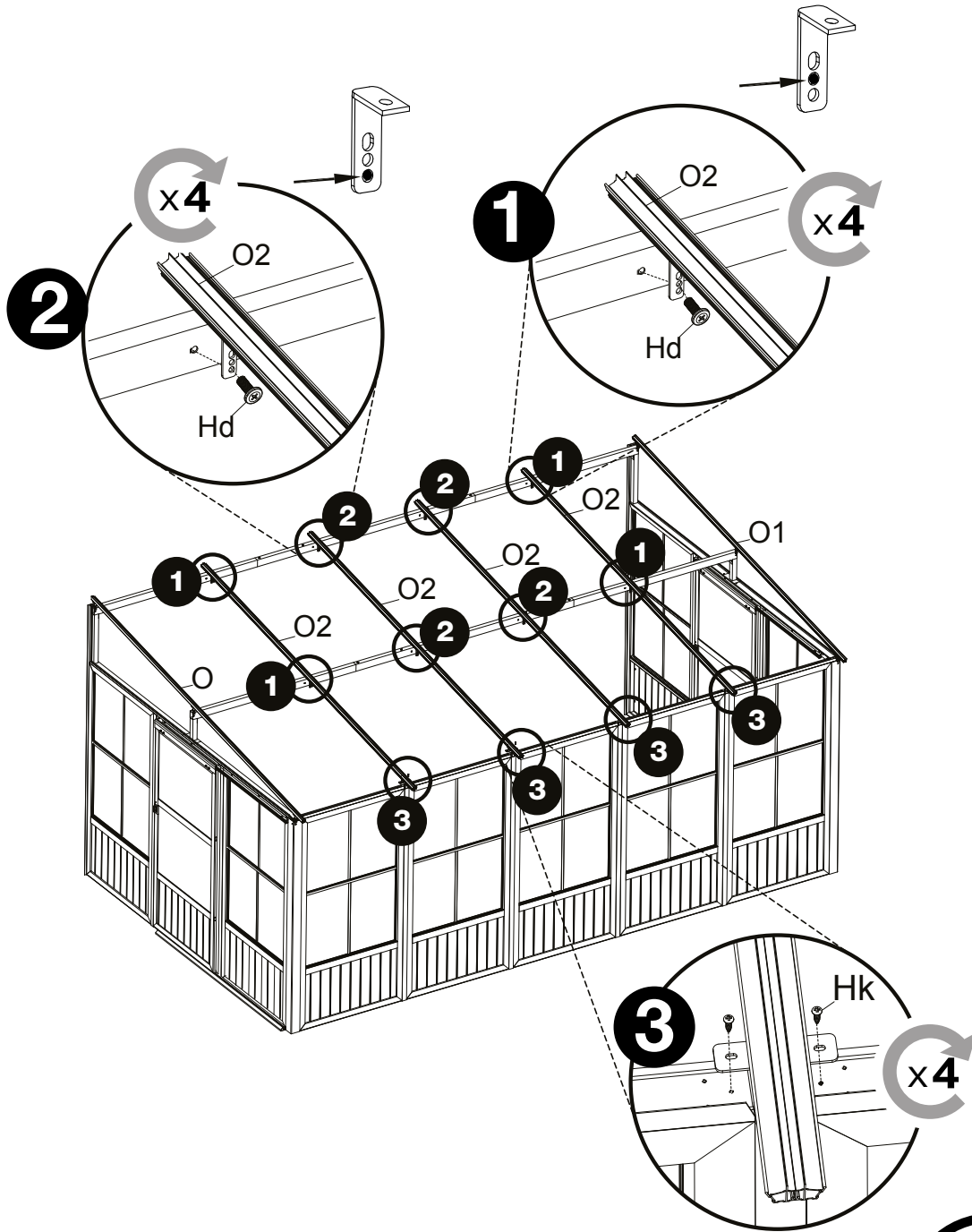

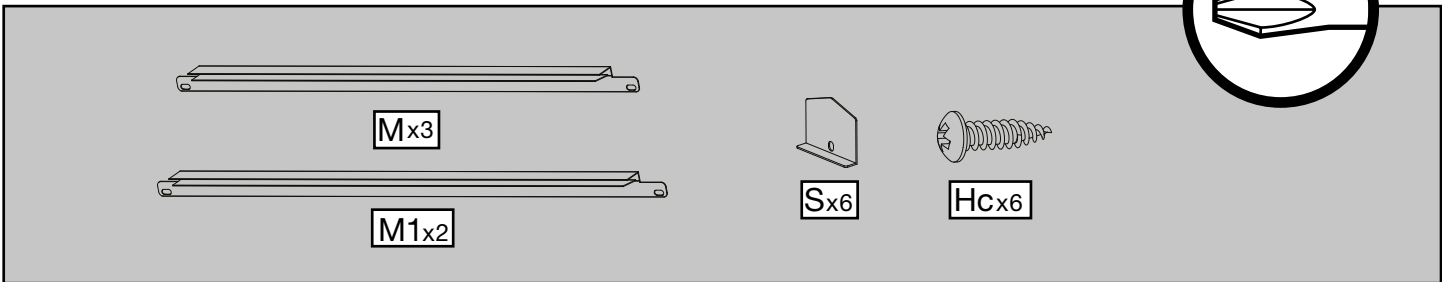
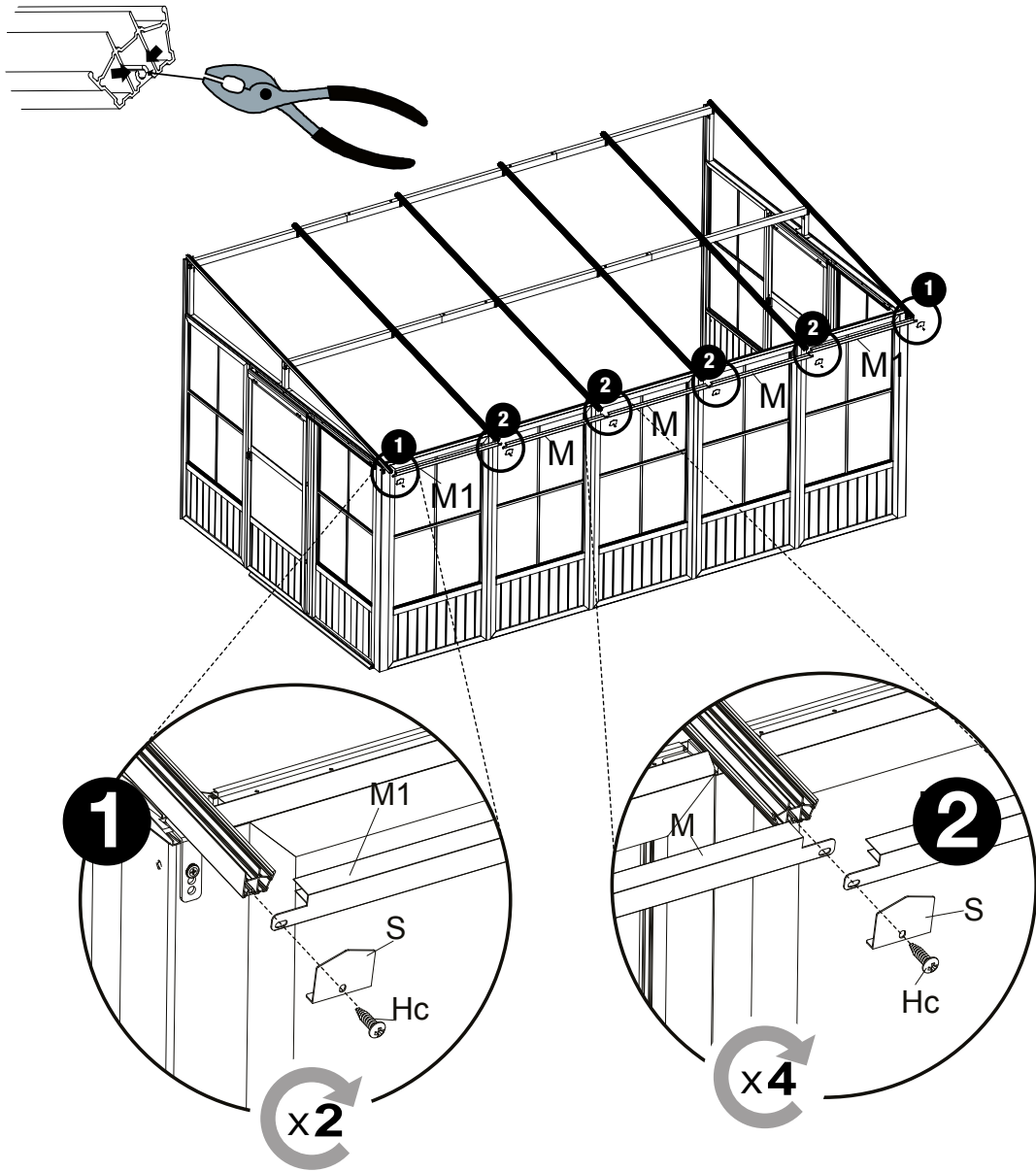

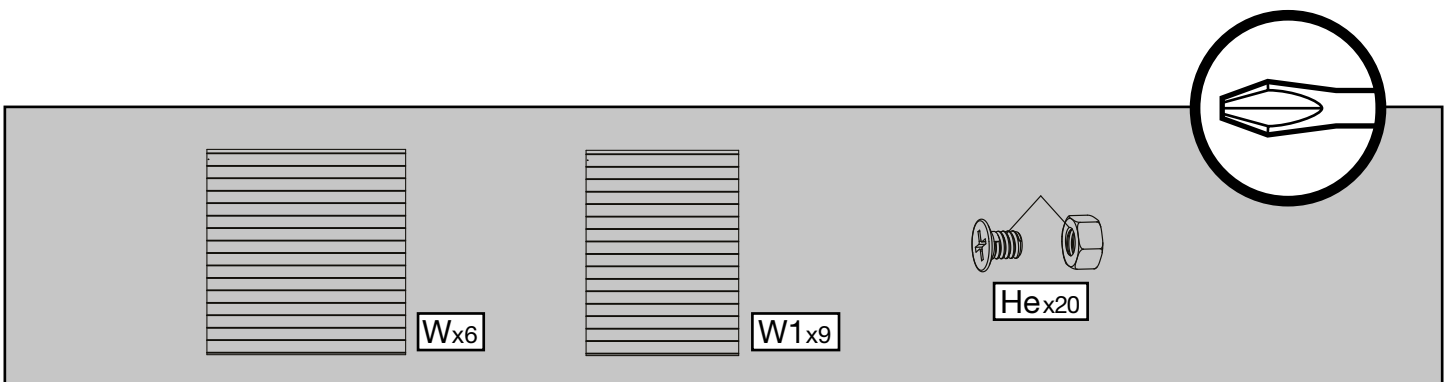
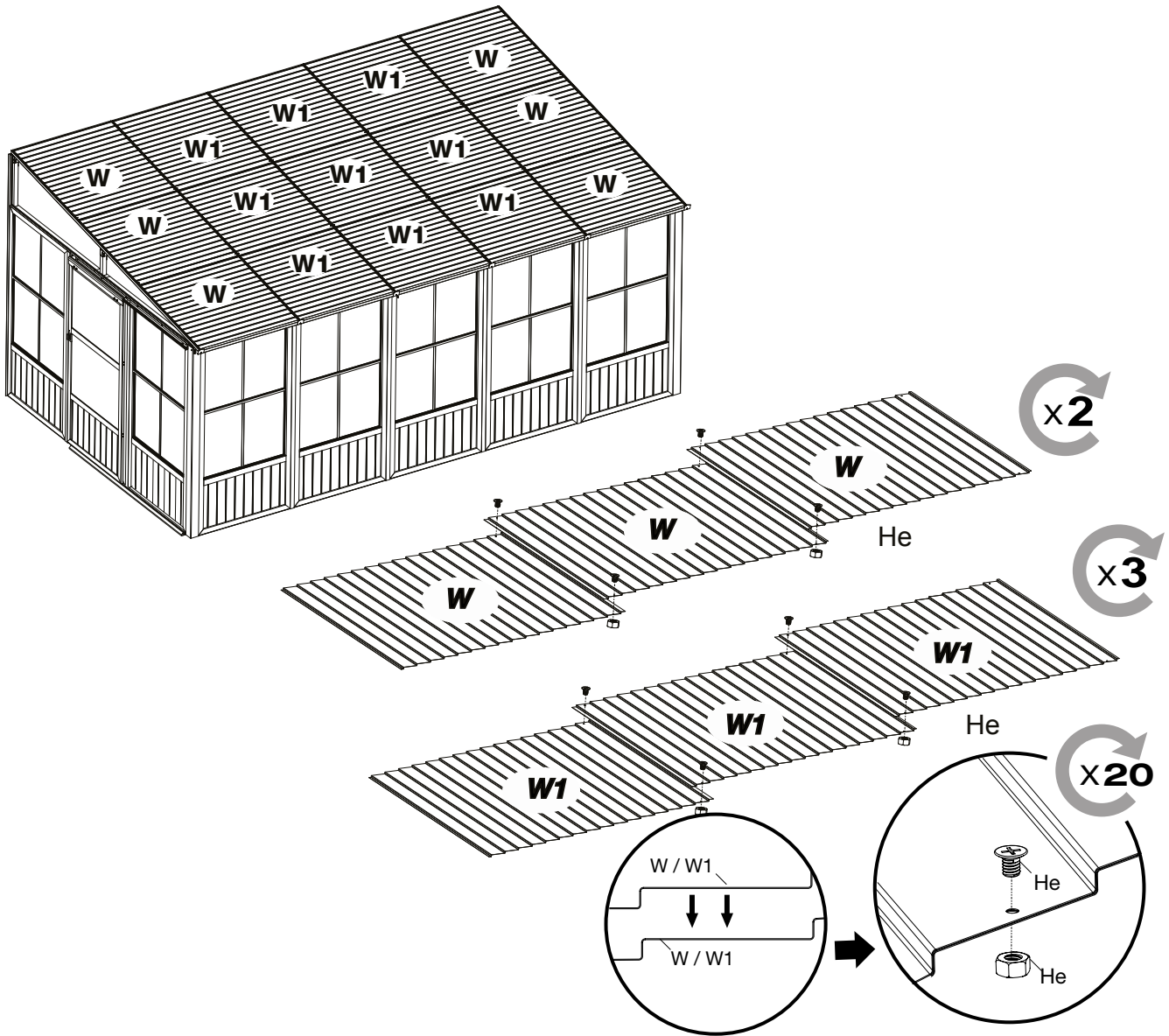

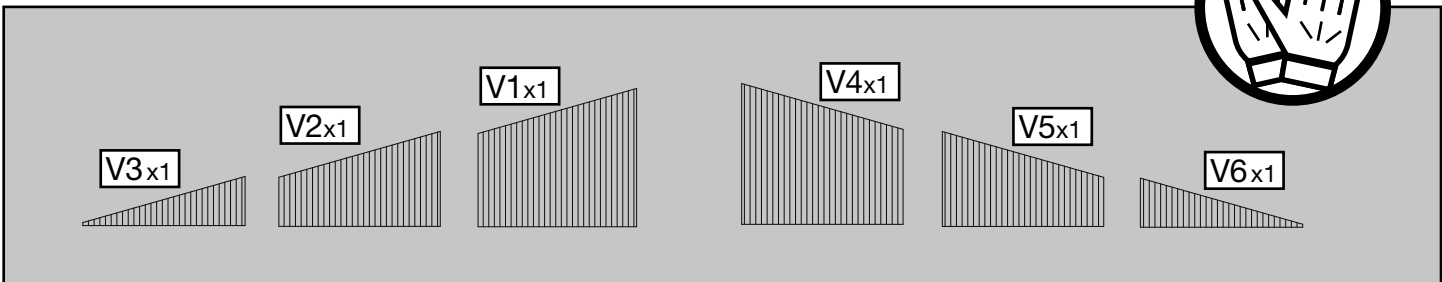
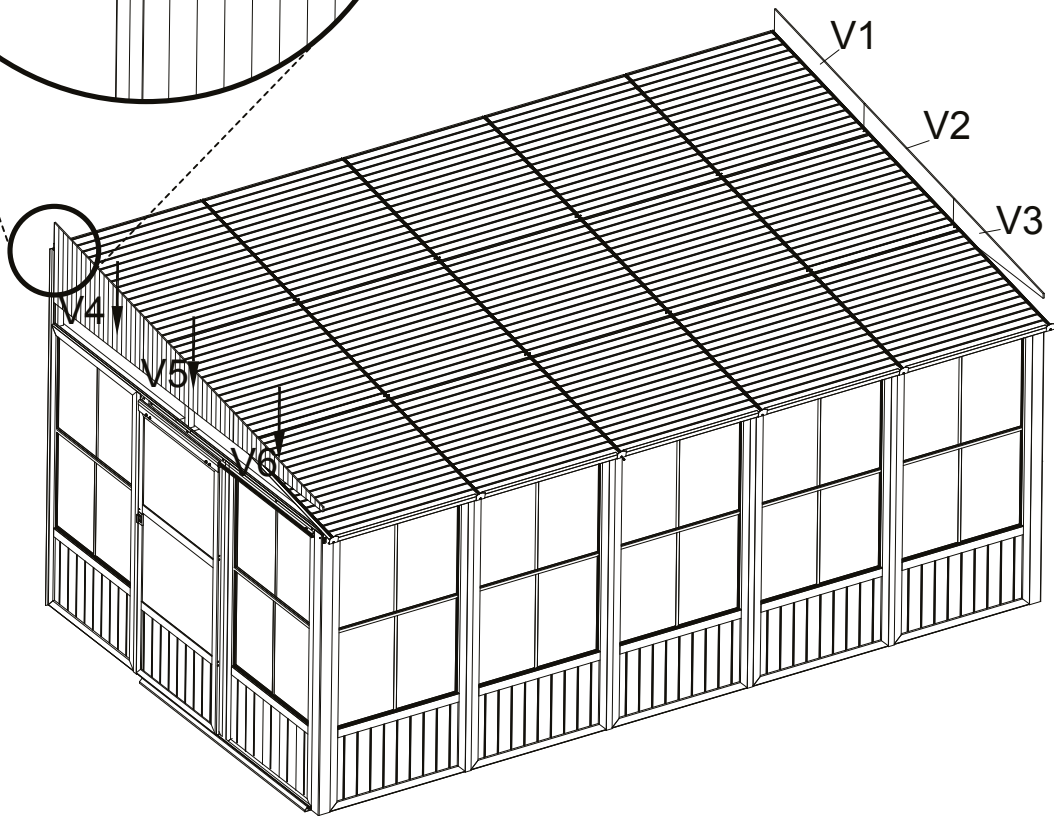
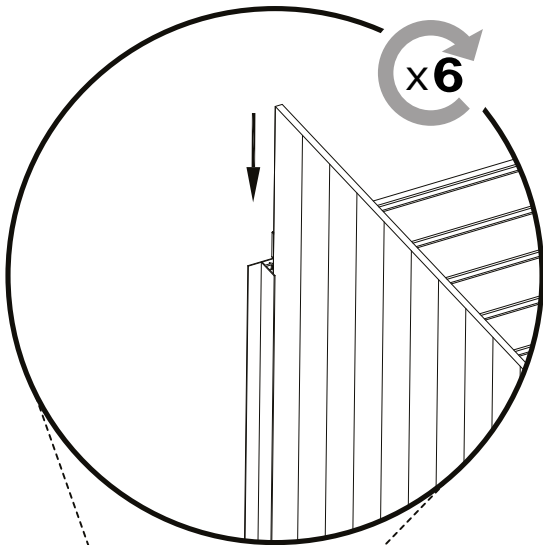

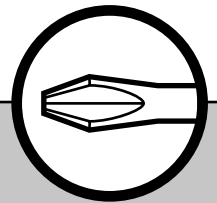
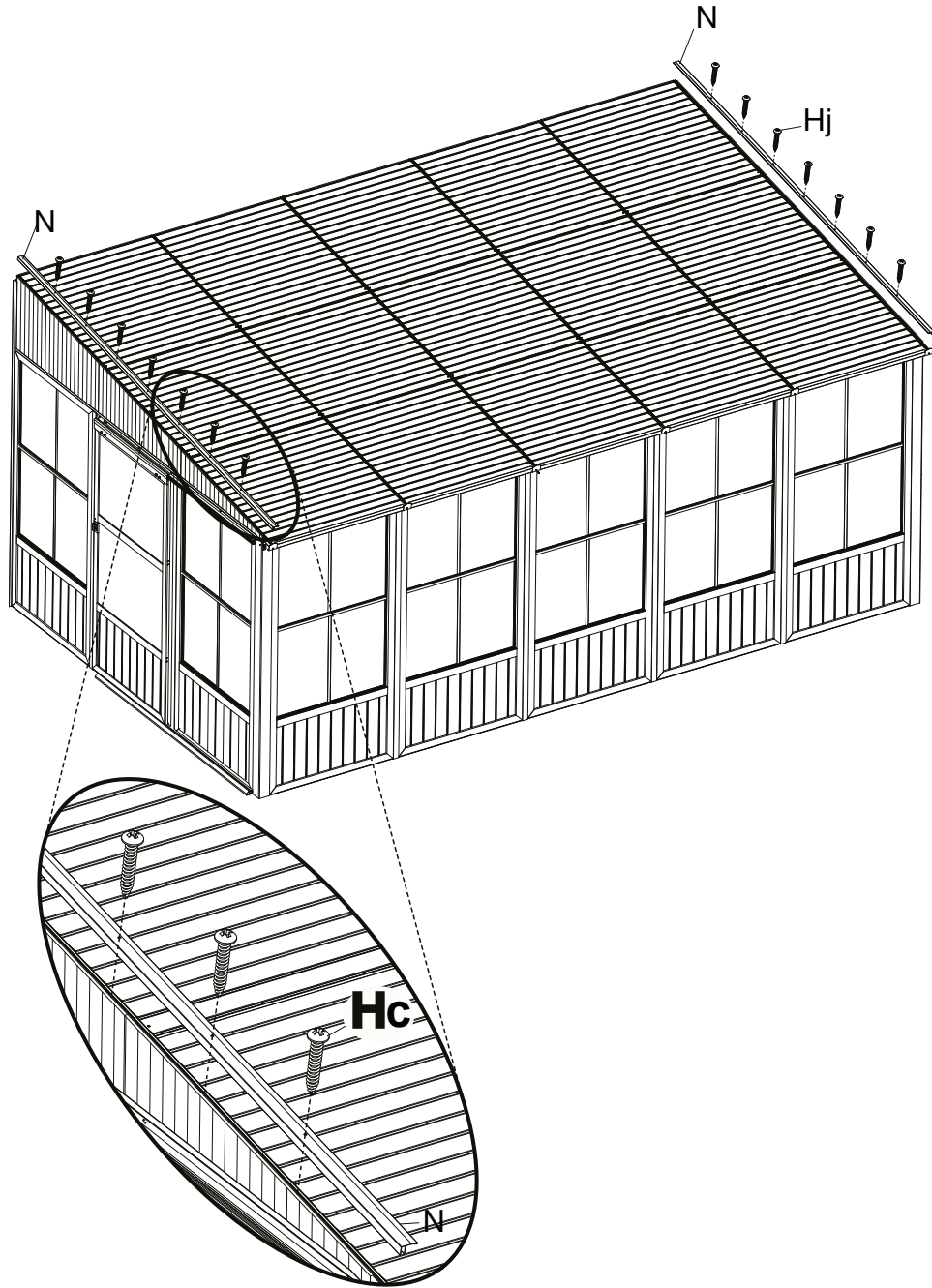

Nx2



Hcx14

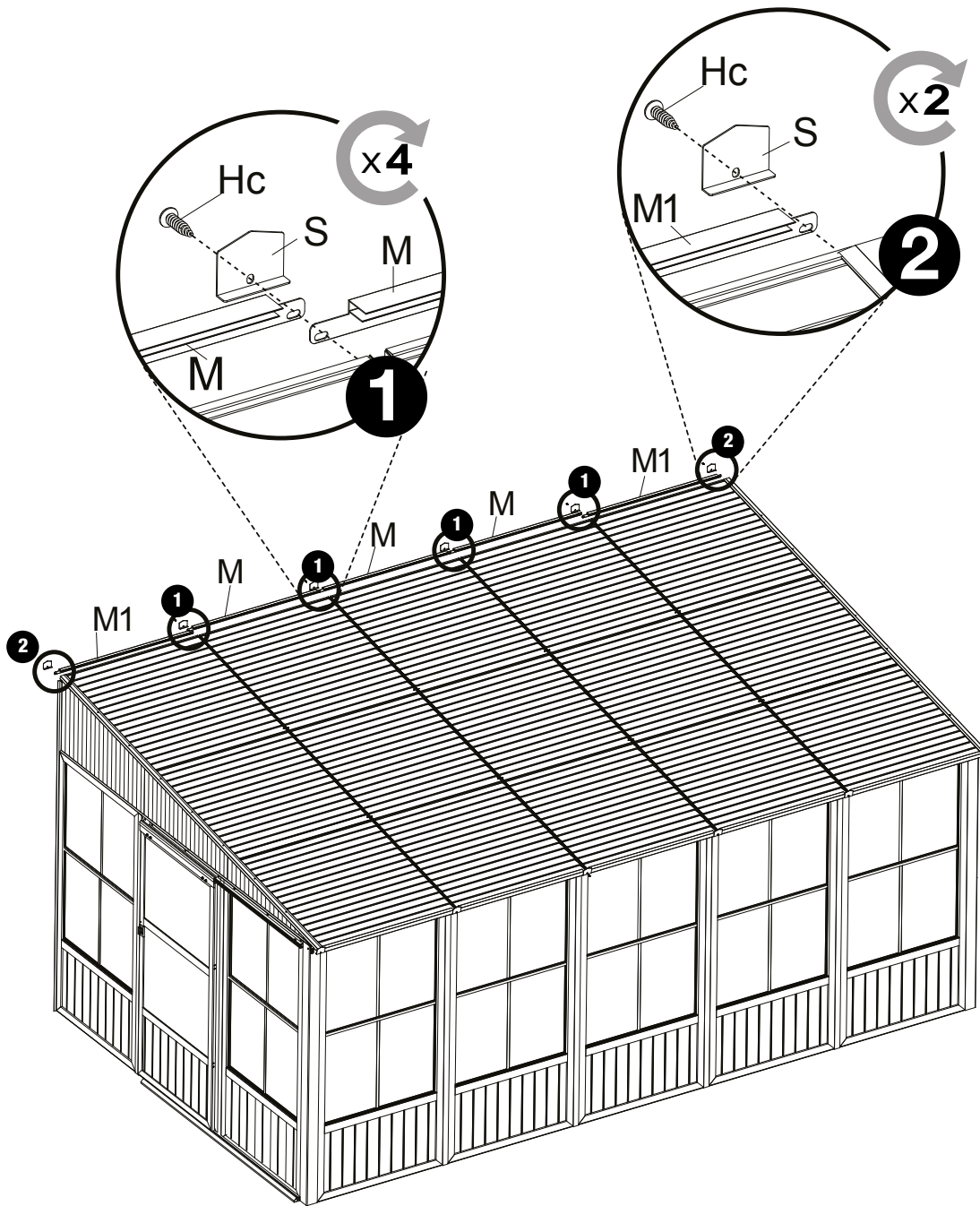

A parts list and tool icon are located at the bottom of the page. The parts list includes:

- Mx3
- M1x2
- Sx6
- HCx6

A circular icon containing a screwdriver is also present.

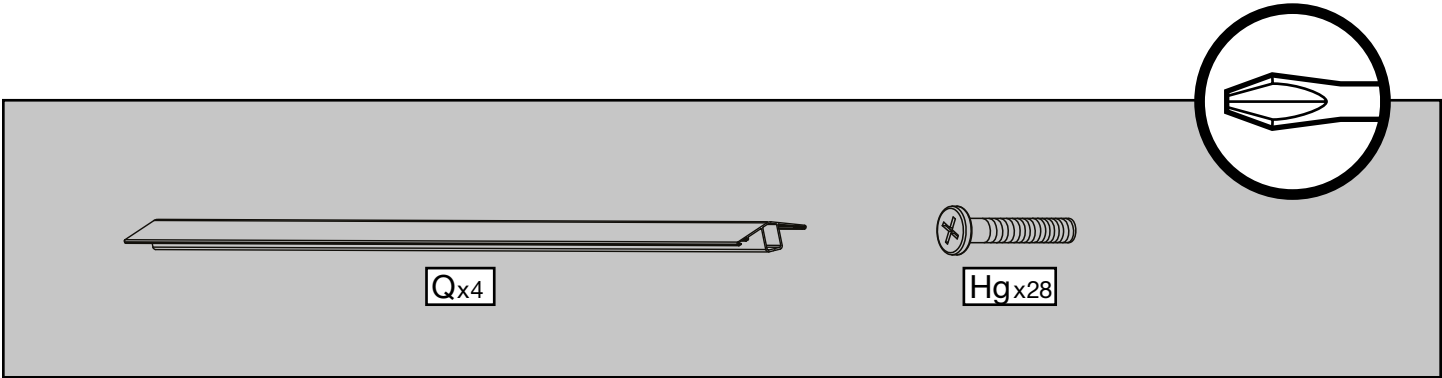
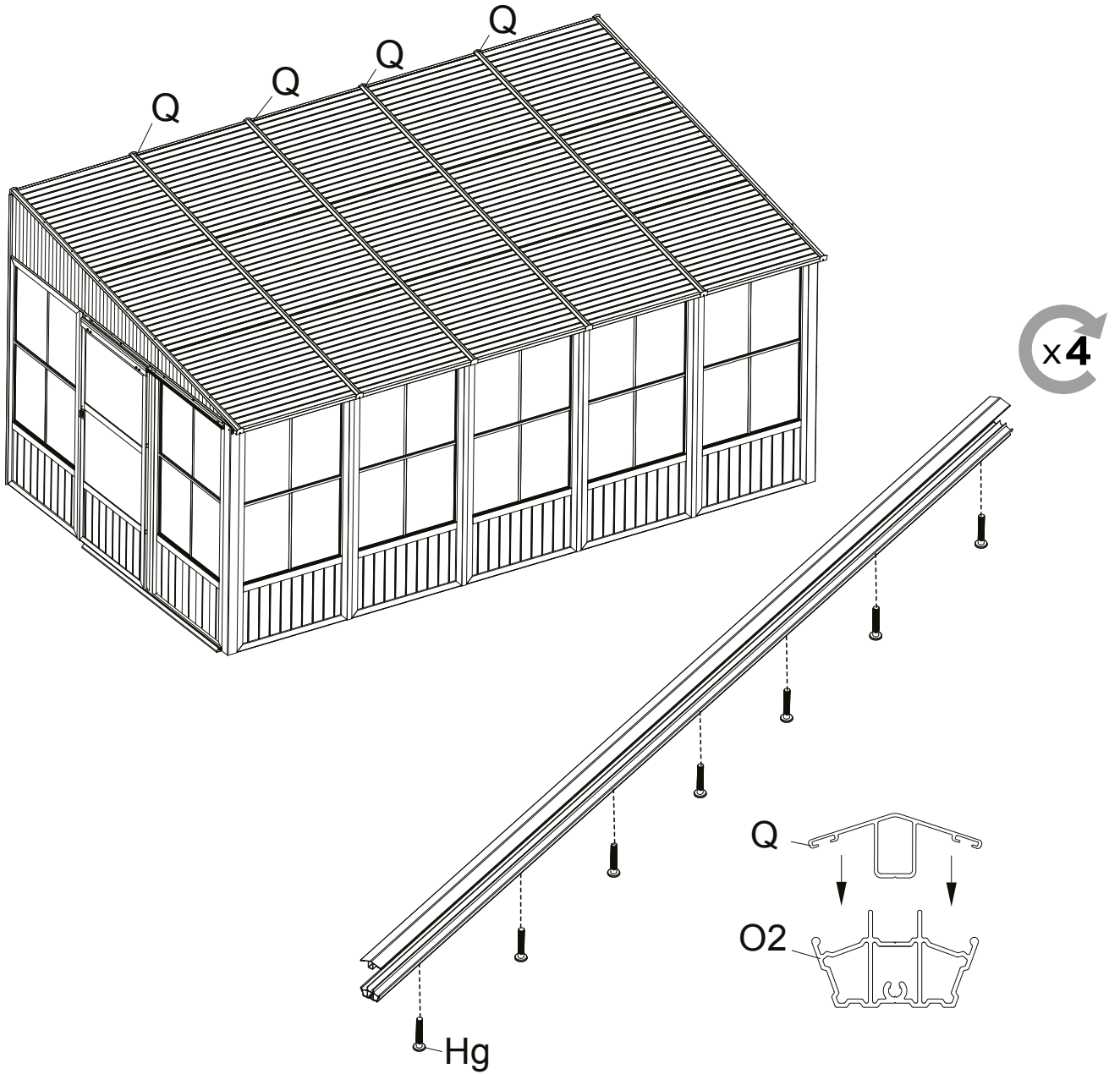

SOJAG ■ I
produits saisonniers • seasonal products